

EFX 883, 833

Warning: This service manual is for use by Precor trained service providers only.

If you are not a Precor Trained Servicer, you must not attempt to service any Precor Product; Call your dealer for service.

This document contains information required to perform the majority of troubleshooting, and replacement procedures required to repair and maintain this product.

This document contains general product information, software diagnostic procedures (when available), preventative maintenance procedures, inspection and adjustment procedures, troubleshooting procedures, replacement procedures and electrical block and wiring diagrams.

To move directly to a procedure, click the appropriate procedure in the bookmark section to the left of this page. You may “drag” the separator bar between this page and the bookmark section to change the size of the page being viewed.

Section One - Things you Should Know

Right, Left, Front, and Back Conventions

In this manual, right, left, front, and back are from the perspective of a user standing on the EFX facing the display enclosure.

General System Information

- The generator performs three functions in the EFX. First, by controlling the amount of electrical load applied to the generator, the user's pedaling resistance is controlled. Second, the generator is used to charge the EFX's internal battery. Lastly, one of the generator's six phase output windings is monitored to determine when the unit is in use and when it is idle. This system also determines the stride rate by determining the operating speed (output frequency) of the monitored generator winding.

Warning and Caution Statements and General Safety Guidelines

Warning statements indicate a particularly dangerous activity. Warning statements you will find in this manual include:

- If the EFX has been in recent use, the load resistors and load resistor mounting bracket may be extremely hot.
- Because this is a self powered unit, it will either be necessary to either equip the unit with the optional external power supply or have an assistant pedal on the unit while voltage measurements are being taken. Because of the danger of working on the unit while it is in motion using the optional external power supply is strongly recommended.
- When the unit is used, stairarms are in motion; the generator will operate and produce potentially hazardous voltages even when the battery is disconnected.
- To remove power from the EFX, the optional external power supply (when equipped) must be disconnected from the wall outlet and the red (positive) lead must be disconnected from the battery. Always ensure that the EFX external power supply is unplugged from the wall outlet and the red (positive) lead is removed from the battery when you inspect or adjust the EFX, or when you isolate, remove, or replace an EFX component.
- Removing the covers exposes high voltage components and potentially dangerous machinery. Exercise extreme caution when you perform maintenance procedures with the cover(s) removed.
- During service operations you will be very close to moving machinery and voltage bearing components. When you perform maintenance procedures with the covers removed, remove jewelry (especially from ears and neck), tie up long hair, remove neck ties, and do not wear loose clothing.
- Exercise caution when touching any wire or electrical component during EFX operation.

- A pinching hazard exists when the unit is operated by turning the crankarms by hand. It is possible to seriously pinch a finger between the crankarm and stairarm. The stairarms should be removed before operating the crankarms by hand. Caution statements are intended to prevent damage to the EFX as a result of the current activity. Caution statements included in this manual are listed below.
- When it is necessary to lift or move the EFX, ensure that the EFX has adequate support and that you use proper lifting techniques.

Safety guidelines you should know and follow include:

- Read the owner's manual and follow all operating instructions.
- Operate the EFX on a solid, level surface. Visually check the EFX before beginning service or maintenance operations. If it is not completely assembled or is damaged in any way, exercise extreme caution while operating and checking the EFX.
- When operating the EFX, do not wear loose clothing. Do not wear shoes with heels or leather soles. Check the soles of your shoes and remove any embedded stones. Tie long hair back.
- Do not rock the unit. Do not stand or climb on the handlebars, display enclosure, or cover.
- Do not set anything on the handlebars, display enclosure, or cover. Never place liquids on any part of the EFX, while performing service.
- To prevent electrical shock, keep all electrical components away from water and other liquids.
- Do not use accessory attachments that are not recommended by the manufacturer-such attachments might cause injuries.

General Information

For the latest exploded view, part number and part pricing information, visit the Precor dealer website at "www.precor.com/connection".

Tools Required

Multimeter	Allen wrench set
Anti-static kit	Screwdriver set
4" - 6" gear puller	7/16" allen key, socket wrench mounted
Precor part number 20030-108 belt gauge	Straight edge
US and metric end wrench set	
US and metric socket wrench set	
Torque wrench, 200 in./lbs.	
Torque wrench, 200 ft./lbs	

Section Two – Precor Console line

Console Line

The EFX with the adjustable incline system will be available with two different console options, the P80 and the P30. The following sections will provide procedures on replacing components and troubleshooting the two consoles. Choose the console section that applies to your EFX.

EFX 883 with P80 Console



TRM 833 with P30 Console



Section Three – P80 Console - EFX



Procedure 3.1 – P80– Systems Settings

Procedure

1. The “Welcome” screen will be the first screen you see when you approach the P80 console. Press the Pause key and continue holding it down while you **double press (prior to 1.1 version software release)** or **single press (1.1 version or after software release)** in sequential order an X configuration on the Volume and Channel key pad (① Channel Up, ② Volume Down, ③ Volume Up, ④ Channel Down). **See Diagram 3.1.1.** Release the Pause key when done pressing the arrows. **Note: The keypad X configuration sequence should be not faster than 1 second between each key stroke.** Any speed faster than 1 second may result in an unsuccessful access to the sign-in screen.

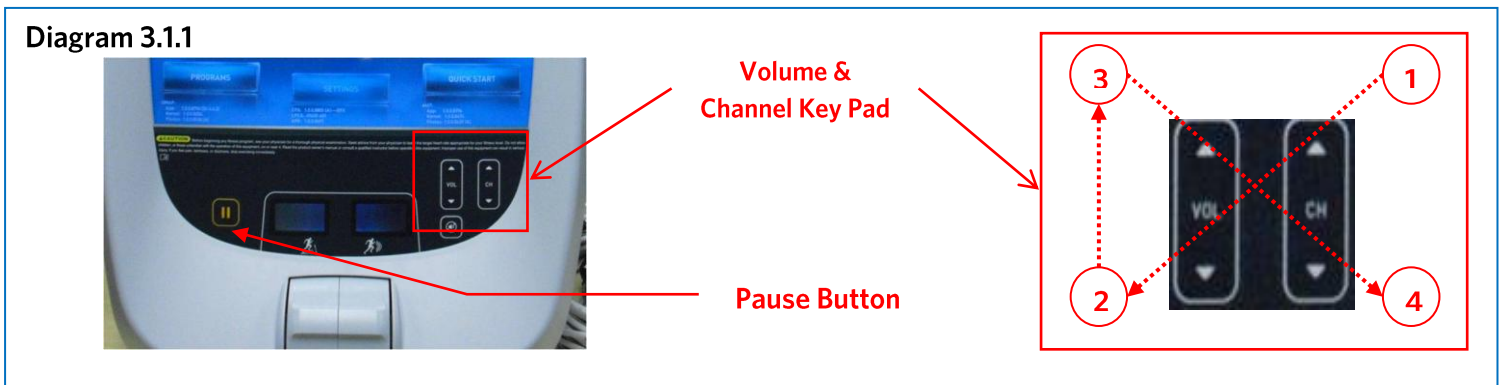

2. The sign-in screen will be displayed. Type in the technician access code and then touch “**OK**”. The “Settings” menu will be displayed. **See Settings Table.**
3. Use the System mode to configure settings in ways that benefit the users and the facility. Changes made to these settings save to the fitness equipment. To select a “Setting” touch on an item in the “**Settings**” menu”.

Settings			
Menu Item	Description	Navigation	Configure/View/Test
About	System information settings provide basic information including equipment models and serial numbers. Most of these settings are for informational purposes only and cannot be modified.	Touch "About"	See Procedure 3.2, About
Equipment Usage	The Equipment Usage settings provide information on individual usage as well as cumulative equipment usage. This information and these settings are accessible only to administrators and registered service technicians.	Touch "Equipment Usage"	See Procedure 3.3, Equipment Usage
System Settings	Use the System Settings to test your equipment and set parameters that benefit your users and your facility. The System Settings menu is visible only to administrators and registered service technicians.	Touch "System Settings"	See Procedure 3.4, System Settings
Software Downloads	Allows software to be automatically downloaded. It is recommended that this remain "ON" at all times. Contact Precor Customer Service before this setting is disabled.	Touch "Software Downloads"	Touch radio button next to "On" to Enable Automatic Downloads. Default is "ON" Touch radio button next to "Off" to Disable Automatic Downloads.
Reflashing	Used in advanced troubleshooting. Contact Precor Customer Service before changing these settings.	Touch "Reflashing"	Contact Precor Customer Service
Available Updates Or No Available Updates (Default)	The default is "No Available Updates" . When "Software Downloads" is enabled and a USB flash drive is installed that contains a valid software package, "Available Updates" will be displayed.	Touch "Available Updates"	Touch next to any of the available updates. Touch "View" to see the details of the update. Touch ◀ BACK to updates list. Touch "Install" to load the update into the console. See Procedure 3.5, Updating Software .

4. Touch **◀ BACK** to the "Welcome" screen.

Procedure 3.2- P80- About

1. Refer to Procedure 3.1 – Settings, to access the About menus.
2. “About” settings provide basic information including equipment models and serial numbers. Most of these settings are for informational purposes only and cannot be modified. **See About Table.** To select a “About” item, touch on an item in the “About” menu.

About			
Menu Item	Descriptions	Navigation	Configure/View/Test
Event Log	Provides a list of the most recent hardware and software events, and equipment status. If no events have occurred since the last time the event log was cleared, the event log screen will be empty.	Touch “ Event Log ”	Details of the Event will be listed. Touch “ REFRESH ” to update the list in the log. Touch “ SAVE ” to save the log to a Flash drive device. Touch “◀ BACK ” to “ About ”
Event Count	Number of events recorded by equipment over its lifetime.	None	None
Console Serial Number	Set by Precor and stored in the console’s memory.	None	None
Lower Serial Number	Stored in the console’s memory. Note: This information is not currently available to be displayed.	None	None
Location	Entered on console at the time of registration.	Touch “ Location ”	Displays location information. Touch “◀ BACK ” to “ About ”
Release Bundle Version	Shows current version of software. Automatically updates as part of each software upgrade.	Touch “ Release Bundle Version ”	Displays detailed information about the current software. Touch “◀ BACK ” to “ About ”
Etag Check Interval:	Determines how often the console will check for updates.	None	None
Heartbeat Interval	Determines how often the console communicates with the Server.	None	None
Minimum Heartbeat Interval	Minimum amount of time between heartbeats to the Preva server.	None	None
Maximum Heart beat Interval	Maximum amount of time between heartbeats to the Preva server.	None	None
Mfe MAC Address	Stored in the consoles memory. Set at factory	None	None
Network Time Server 1	These addresses are set at the factory and will not need to be changed in the field.	None	None
Network Time Server 2	These addresses are set at the factory and cannot be changed in the field.	None	None
Network Time Server 3	These addresses are set at the factory and cannot be changed in the field.	None	None
Machine Type	Type of equipment (AMT, RBK, UBK, EFX, & TRM). Set at factory.	None	None

3. Touch ◀**BACK** to Settings. Procedure 3.1.

Procedure 3.3- P80 – Equipment Usage

1. Refer to Procedure 3.1 – Settings to access the Equipment Usage menus.
2. The Equipment Usage settings provide information on individual usage as well as cumulative equipment usage. **See Equipment Usage Table.**
3. The “Equipment Usage” screen currently does not have additional detail or test screens.

Equipment Usage			
Menu or Information Item	Description	Navigation	Detail or Test
Cumulative Workout Seconds	Total number of seconds. Seconds are counted when the workout clock starts	None	None
Cumulative Workout Distance	<ul style="list-style-type: none"> • Treadmills will report miles of use. • AMTs will report a “horizontal distance” as miles. • Ellipticals will convert total strides to miles. • Bikes will convert total revolutions to miles 	None	None
Cumulative Work Out Sessions	Total number of sessions. A session is counted if the summary screen displays.	None	None
Last Workout Start Date Time	The date of the start of the last workout.	None	None
Last Workout End Date Time	The date of the end of the last workout.	None	None

4. Touch ◀ **BACK** to Settings. Procedure 3.1.

Procedure 3.4 – P80– System Settings

1. Refer to Procedure 3.1 – Settings, to access the Equipment Usage menus.
2. Use the System Settings to test your equipment and set parameters that benefit your users and your facility.

System Settings			
Menu or Information Item	Description	Navigation	Configure/View/Test
Systems Test	The systems tests allow you to check specific functions of the equipment.	Touch “ Systems Test ”	See Procedure 3.6
Connectivity	The connectivity screens allow you to configure or provides information about the equipment’s network connection.	Touch “ Connectivity ”	See Procedure 3.7
Display	The display settings allow you to configure, Measurement units, Standby Mode Delay, Time Zone, and Closed Captioning.	Touch “ Display ”	See Procedure 3.8
TV Settings	TV Settings help you set up television channels for your users.	Touch “ TV Settings ”	See Procedure 3.9
Work out Limits	The Workout Limit settings give you control over how the equipment is used. Use these settings to create reasonable limitations for equipment usage including speed, incline, resistance, and duration.	Touch “ Workout Limits ”	See Procedure 3.10
Manage Settings	Use this setting to save your equipment settings to a USB flash drive, or to import settings from a USB flash drive.	Touch “ Manage Settings ”	See Procedure 3.11 (Cloning)

Procedure 3.5 – P80 – Updating Software

The P80 console is driven by software with innovative features which enhances the user's experience during a workout. Periodically the software will need to be updated with improvements to the functionality and features. Procedure will explain how to update the software at the customer's location using a USB Flash drive device for P80 consoles.

A USB Flash drive device with pre-loaded software or a web site location where you can upload the software onto a USB Flash drive device will be provided by PRECOR.

Procedure to update (Flash) software for P80 consoles:

1. The "Welcome" screen will be the first screen you see when you approach the P80 console. Press the Pause key and continue holding it down while you **double press (prior to 1.1 version software release)** or **single press (1.1 version or after software release)** in sequential order an X configuration on the Volume and Channel key pad (① Channel Up, ② Volume Down, ③ Volume Up, ④ Channel Down). **See Diagram 3.1.1.** Release the Pause key when done pressing the arrows. **Note: The keypad X configuration sequence should be not faster than 1 second between each key stroke.** Any speed faster than 1 second may result in an unsuccessful access to the sign-in screen.

Diagram 1

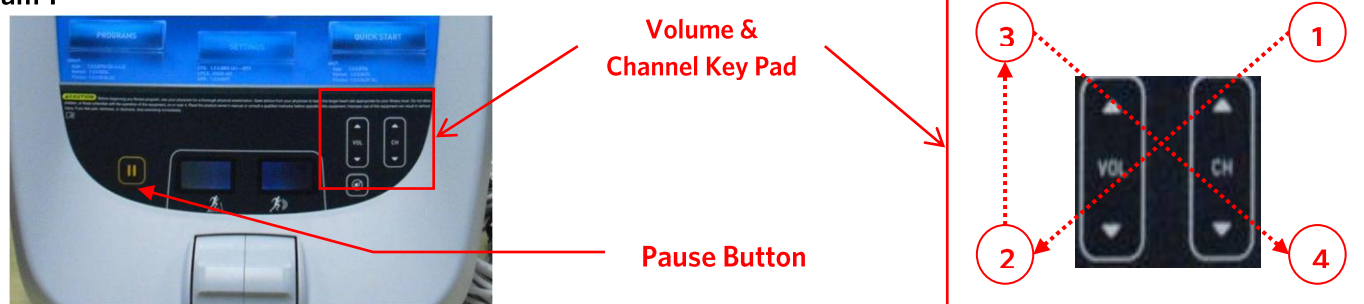

2. The sign-in screen will be displayed. Type in the technician access code and press enter.
3. Insert the USB Flash Drive into the USB Drive Port of the P80 console. **See Diagram 2.**

Diagram 2



4. The P80 software will automatically access the USB Flash Drive files and look for a valid software update. While the USB Flash Drive is being validated, "No Updates Available", will be displayed on the P-80 console screen. Once an update file has been identified and validated, "Updates Available", will be displayed on the P-80 console screen. Touch the spot on the P80 console screen where "Updates Available" is displayed to select.
5. A software package or list of software packages will be displayed on the P80 console screen. Touch the spot on the P80 console screen displaying the software package required.

Note: PRECOR customer service will specify which software package is required when the service is requested to update P-80 Console software. If you are unsure of which software package should be installed, contact PRECOR customer service.

6. Touch the spot on the screen displaying "Install" and the P80 console will start the software installation process. The software installation process can take up to 35 minutes and the console will automatically reboot when it has finished.
7. Once the download as started it is safe to remove the USB Flash Drive device from the P80 USB port.
8. When the P80 has completed rebooting the "Welcome" screen will be displayed. The installation of the software update is now complete.
9. Verify the correct version of software has been installed. This can be found by accessing the main menu using the instructions provided in steps 1 and 2, then selecting "About." The software version will be displayed under "Installed Bundle Version and should match the package selected in step 5.

Procedure 3.6- P80 – Systems Tests

1. Refer to Procedure 3.1 – Settings, to access the Equipment Usage menus.
2. The systems tests allow you to check specific functions of the equipment.
3. To select a “**Systems Test**” touch on an item in the “**Systems Test**” menu”.

Systems Tests		
Test	Equipment	Description
Auto Stop Test	TRM Only	<ol style="list-style-type: none"> 1. Touch “Auto Stop Test”, then Touch “START”. 2. The Auto stop test will start the belt at 1 mph; count will be reset to 0, and then count up with each step. 3. Touch “STOP” to end the test. Touch “◀ BACK” to exit to Systems Test.
Belt Speed Test	TRM Only	<ol style="list-style-type: none"> 1. Touch “Belt Speed Test”, then Touch “START”. 2. The belt will start a 0.5 mph, using the machine control paddle to increase by 0.1 mph increments. The console will display motor current as the belt speed increases or decreases. 3. Touch “STOP” to end the test. Touch “◀ BACK” to exit to Systems Test.
Incline Test	TRM Only	<ol style="list-style-type: none"> 1. Touch “Incline Test”, and then Touch “START”. 2. Use the machine control paddle to change the lift. The console will display the analog to digital (A/D) incline position number and the incline position in percent of incline. 3. Touch “STOP” to end the test. Touch “◀ BACK” to exit to Systems Test.
AMT Stride Position Test	AMT Only	<ol style="list-style-type: none"> 1. Touch “AMT Stride Position Test” and then Touch “START”. 2. The High, Low and Dynamic positions will be displayed. The low position display shows the lowest position reading achieved during the test. The high position display shows the highest position reading achieved during the test. The dynamic position display changes with current stride position. Stride on the AMT to the maximum horizontal movement in both directions. At maximum stride length the low stride display should read “0” and the high stride display should read 40. 3. Touch “STOP” to end the test. Touch “◀ BACK” to exit to System Tests.
Brake Test	AMT, RBK, UBK, EFX	<ol style="list-style-type: none"> 1. Touch “Brake Test”, then Touch “START”. 2. Use the machine control paddle to change the resistance up and down. The resistance changes will be displayed in power bits. 3. Touch “STOP” to end the test. Touch “◀ BACK” to Systems Test.

Systems Tests Continued		
Battery Test	AMT, RBK, UBK, EFX	<ol style="list-style-type: none"> 1. Touch "Battery Test", and then Touch "START". 2. The console will display the voltage of the battery. 3. Touch "STOP" to end the test. Touch "◀ BACK" to Systems Test.
SPM	AMT, EFX	<ol style="list-style-type: none"> 1. Touch "SPM Test", and then "START". 2. The console will display Pulse. The pulse is showing a count of zero crossings from the generator. SPM shows a software averaged version of pulse. A averaged pulse per minute will display as Minimum and a Maximum pulse. 3. Touch "STOP" to end the test. Touch "◀ BACK" to exit to Systems Tests.
RPM Test	RBK, EFX	<ol style="list-style-type: none"> 1. Touch "RPM Test", and then "START". 2. The console will display Pulse. The pulse is showing a count of zero crossings from the generator. RPM shows a software averaged version of pulse. 3. Touch "STOP" to end the test. Touch "◀ BACK" to exit to Systems Test.
CrossRamp	EFX Only	<ol style="list-style-type: none"> 1. Touch "CrossRamp Test", and then Touch "START". 2. Use the machine control paddle to change the CrossRamp. The console will display the analog to digital (A/D) and Glitches incline position number. Available battery voltage to the lift system will be displayed. 3. Touch "STOP" to end the test. Touch "◀ BACK" to Systems Test.
USB Test	All	<ol style="list-style-type: none"> 1. Touch "USB Test". 2. The USB Test will show the number of USB ports currently active, there should be six. Insert a USB Flash drive into the USB port and then Touch "CLOSE", and then Touch "USB Test" again. The number of active USB ports should be increased by one. 3. Touch "CLOSE" to exit to Systems Test.
Touchscreen Test	All	<ol style="list-style-type: none"> 1. Touch "Touchscreen Test". 2. Place your finger on one corner of the screen and run it around the edges multiple times. 3. The line drawn by your finger should be very close to previous passes. Be sure that you do not touch anything else with your other hand. 4. Touch "FINISH" to exit to Systems Test.

Systems Tests Continued		
Touchscreen Calibration	All	<ol style="list-style-type: none"> 1. Touch "Touchscreen Calibration". 2. A "+" will be displayed on a white screen. Touch the "+", the spot you just touched will disappear and then be replaced with another "+" in a different location on the white screen. 3. Continue to touch the "+" as they appear on the screen until the test automatically exits to the Systems Test screen. You cannot exit this test until all the "+" have been touched and the screen is calibrated.
Backlight Test	All	<ol style="list-style-type: none"> 1. Touch "Backlight Test". 2. The backlight will display three levels of brightness, 100%, 60%, and 0% in succession in 1 second intervals, returning to the System Tests menu when complete.
RGB Test	All	<ol style="list-style-type: none"> 1. Touch "RGB Test". 2. The full screen should move through a succession of five colors, requiring a touch anywhere on the screen to advance to the next. These are Red, Green, Blue, Black, White, returning to the Systems Tests menu when all the displayed colors have been touched.
Speaker Test	All	<ol style="list-style-type: none"> 1. Touch "Speaker Test". 2. This test will send an audible sound to the speaker mounted in the headphone jack and while providing a graphic of a scrolling bar on the screen. When the test is complete it will automatically exit to the Systems Test screen.
Numeric Backlight Test	All	<ol style="list-style-type: none"> 1. Touch "Numeric Backlight Test". 2. This tests the back lights of the lower display just above the paddle controls. The back lights of the display will illuminate in sequence and then automatically exit to the Systems Test screen.
Numeric Display Test	All	<ol style="list-style-type: none"> 1. Touch "Numeric Display Test". 2. This will test the numeric LCD display just above the paddle controls. All the numeric characters will be displayed in sequence and then automatically exit to the Systems Test.
Heart Rate	All	<ol style="list-style-type: none"> 1. Touch "Heart Rate". 2. Grasp both of the heart rate grips on the handlebar, after a couple of seconds the heart rate will be displayed. 3. Touch "◀ BACK" to exit to Systems Test.

3. Touch **◀ BACK** to Settings. Procedure 3.1.

Procedure 3.7 – P80- Connectivity

Configuring your audio, video, and network infrastructure requires expertise. Precor strongly recommends that you work with a qualified contractor to set up this infrastructure.

This setting provides the following information:

- Network Type
 - Wired (Default)
 - Wireless (This is a selectable option but is not currently supported)
- Configuration
- Status
- IP Address
- Preva Server

To view connectivity information:

1. Refer to Procedure 3.1 – Settings, to access the Connectivity menus.
2. To select a **“Connectivity Setting”** touch on an item in the **“Connectivity Settings”** menu”.

Connectivity settings		
Settings	Default	Detail
Network Type	Wired	
Configuration	Automatic	Automatic (DHCP) or Manual (Static IP) Press Network Settings to view the <ul style="list-style-type: none"> • IP Address • Netmask • Gateway • DNS Primary • DNS Secondary
Status	N/A	<ul style="list-style-type: none"> • Connected –Connected to the network. • Not Connected - Not connected to the network
IP Address	N/A	Location-specific
Preva Server		na.preva.precor.com

Connectivity Set Up and Registration Procedure

1. Before you attempt to connect to the Precor Preva Server, check the status field and ensure that the “Connected” is displayed. If the Status field shows “Not Connected”, you will need to diagnose your networking issue. Continue with Step 2. If the Status Field shows “Connected” go to step 3. **See Diagram 3.7.1**
2. Either the Ethernet cable is not connected or there is a problem with the network connection. Check the connection and then check the Status field again. If the Status field shows “Connected” continue with step 3. If the Status field still shows “Not Connected” contact your IT expert.

Diagram 3.7.1

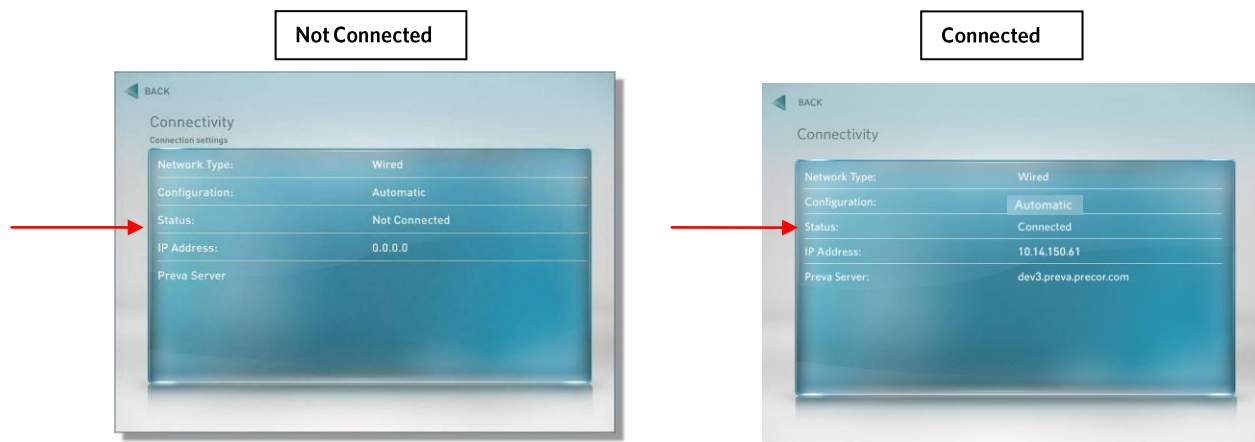

3. Check the IP Address field for a valid IP Address. If the IP Address is present continue with step 12. If the IP Address is not present continue with step 4. **See Diagram 3.7.2.**

Diagram 3.7.2

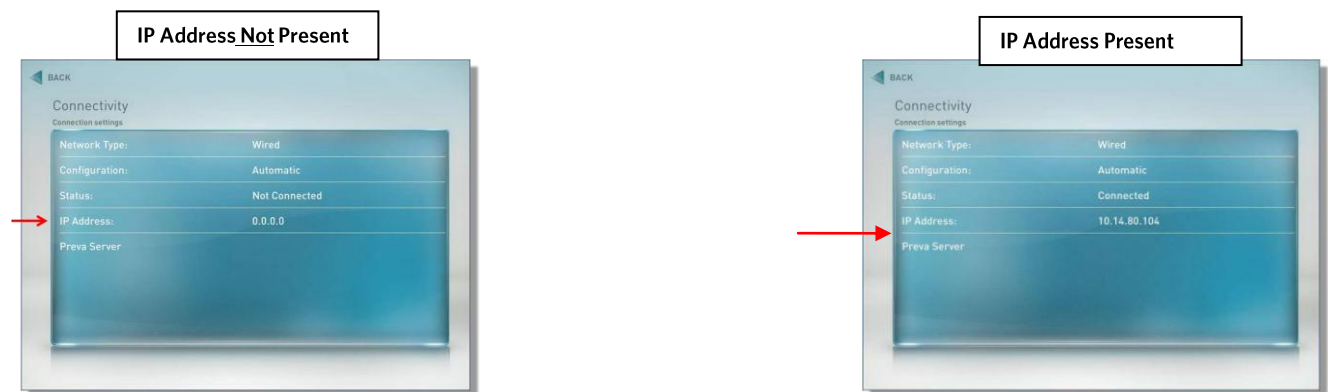

4. If the Status shows Connected and the IP Address is not present, it will be necessary to either have the P80 software assist in acquiring the IP Address (Recommended) or enter the IP address manually. Touch "Configuration" from the Connectivity menu.
5. Touch on the radio button next to "Automatic", and then touch "SETTINGS". **See Diagram 3.7.3.**

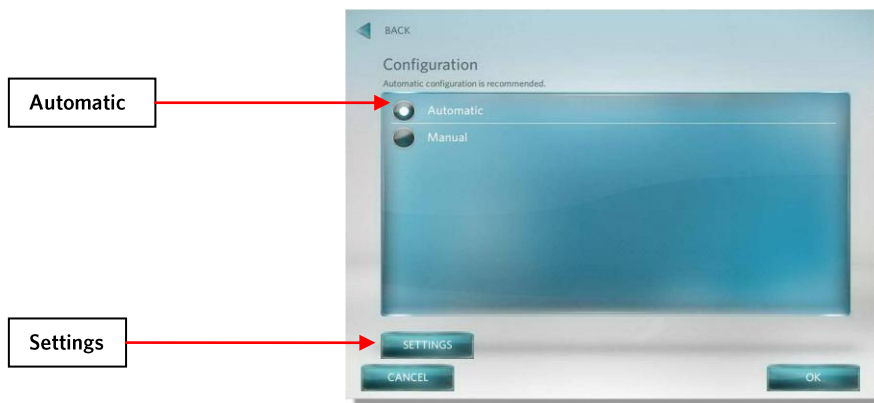
Diagram 3.7.3

6. The P80 will attempt to connect to the network, and when successful will acquire the networking information necessary for registration. If the console was already connected, it will skip straight to the 'Network Settings' screen and display the current network information. Once a good IP Address has been acquired, the P80 can now be registered. Continue with step 12.
7. Note: Manually setting up the network configuration is not recommended. Precede with the following procedure only with assistance from the facilities IT staff. Touch "Configuration" form the Connectivity menu.
8. Touch on radio button next to "Manual", and then touch "SETTINGS". **See Diagram 3.7.4.**

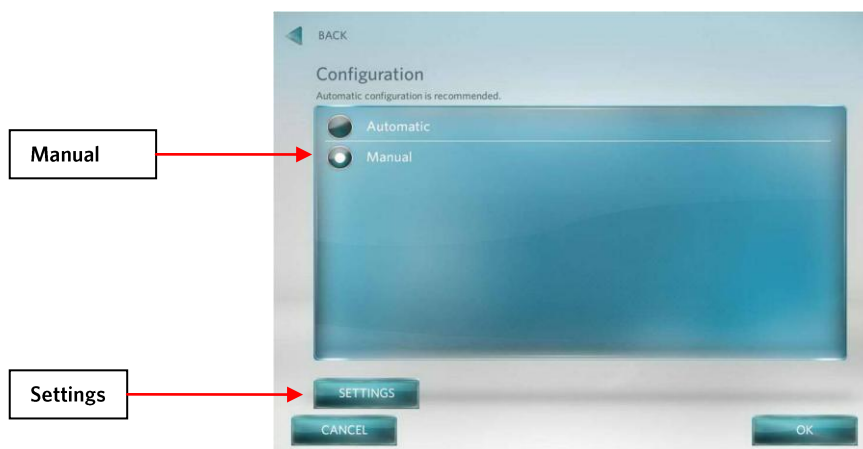
Diagram 3.7.4

9. Touch one of the network settings items from the Connectivity menu.
10. Enter the data acquired from the network administrator using the on-screen key pad, and then select "OK". **See Diagram 3.7.5.**
11. Repeat steps 9 and 10 for the remaining network settings.

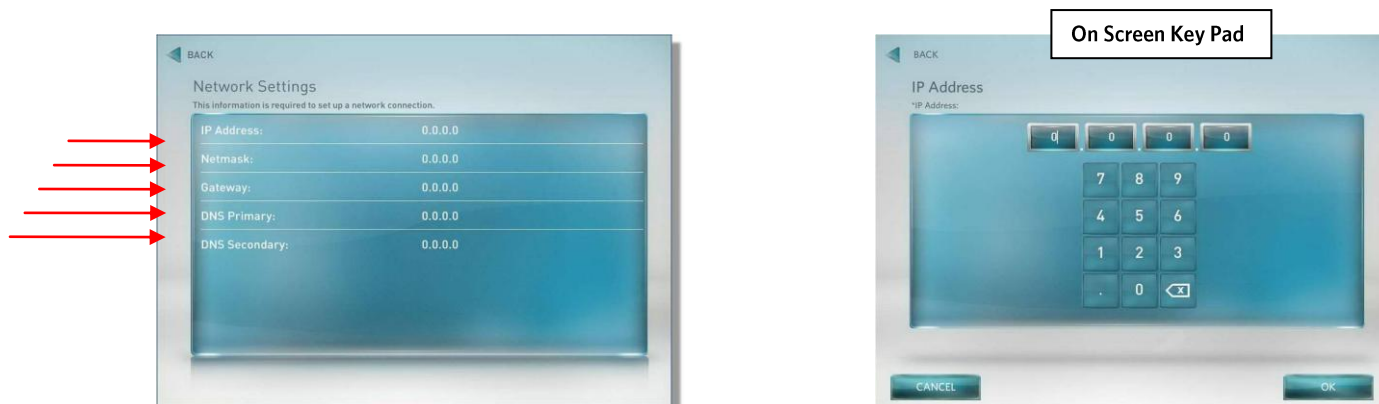
Diagram 3.7.5

12. Once a good IP Address is displayed, touch "Preva Server" to enter the web address.
13. If you are in North America enter **na.preva.precor.com** by using the on-screen keypad.
14. Touch "**OK**".
15. A screen will appear stating, "The equipment is ready to be set up", touch "USER NAME AND PASSWORD".
16. The user name and password will have been provided by Precor prior to installation. Enter the user name using the on-screen keypad, then touch "**NEXT**".
17. Enter the password using the on-screen keypad, then touch "**NEXT**".
18. The next screen will list information that you need to know before continuing with the registration process.
 - Site Code
 - Base Serial Number
 - Friendly Name

Site Code - This is given at the time of the dispatch.
 Base Serial - The base serial number is located on the exercise equipment.
 Friendly Name - It is recommended that you have a list of the equipment with "friendly names" already assigned, such as Elliptical 1, Treadmill 22, and so forth. Touch "**NEXT**".
19. Enter the Site Code using the on-screen keypad, then touch "**NEXT**".
20. Enter the Base Serial Number using the on-screen keypad, then touch "**NEXT**".
21. Enter the Friendly Name using the on-screen keypad, then touch "**NEXT**".
22. The next screen displayed will be the Registration Summary screen. Review the screen to ensure the information entered is correct before completing the registration. If the information is not correct touch "**BACK**" until the screen with incorrect information is displayed. Make the corrections and then touch "**NEXT**" until you are back at the Registration Summary Screen.
23. Touch "Register" to submit the data.
24. If the registration was successful a screen with current software version will be displayed. Touch "**FINISH**" to the Systems Settings menu, if a newer software version is available, the console will automatically start the download.
25. Touch **BACK** to Settings. Procedure 3.1.

Procedure 3.8 – P80- Display

The display settings allow you to configure Measurement units, Standby Mode Delay, Time Zone, and Closed Captioning.

1. Refer to Procedure 3.1 – Settings, to access the Display menus.
2. To select a **“Display Settings”** touch on an item in the **“Display”** menu”.

Display			
Settings	Settings Options	Default Fault	Configure/View/Test
Language	<ul style="list-style-type: none"> • German • English • Spanish • French • Italian • Dutch • Russian • Japanese 	English	<ol style="list-style-type: none"> 1. Touch “Language” 2. Touch on a radio button next to the desired language, a dot will fill the radio button next to the selection. 3. Touch “OK” or “CANCEL” to exit to the Display menu.
Measurement Units	US Standard or Metric	US Standard	<ol style="list-style-type: none"> 1. Touch “Measurement Units” 2. Touch on a radio button next to either US Standard or Metric; a dot will fill the radio button next to the selection. 3. Touch “OK” or “CANCEL” to exit to the Display menu.
Standby Mode Delay	<ul style="list-style-type: none"> • 5 Minutes • 15 Minutes • 30 Minutes • 60 Minutes 	15 Minutes	<ol style="list-style-type: none"> 1. Touch “Standby Mode Delay”. 2. Touch on a radio button next to the desired delay time, a dot will then fill the radio button. 3. Touch “OK” or “CANCEL” to exit to the Display menu.
Time Zone	GMT-12 through GMT + 12	GMT - 00-10	<ol style="list-style-type: none"> 1. Touch “Time Zone”. 2. Touch on the radio button next to the desired Time Zone, a dot will fill the radio button. 3. Touch “OK” or “CANCEL” to exit to the Display menu.
Closed Captioning	ON/OFF	ON	<ol style="list-style-type: none"> 1. Touch “Closed Captioning” 2. Touch on a radio button next to either ON/OFF, a dot will fill the radio button next to the desired selection. 3. Touch “OK” or “CANCEL” to exit to the Display menu.

4. Touch **BACK** to Settings. Procedure 3.1.

Procedure 3.9 – P80- TV Settings

The display settings allow you to configure Measurement units, Standby Mode Delay, Time Zone, and Closed Captioning.

1. Refer to Procedure 3.1 – Settings, to access the TV Settings menus.
2. To select a “**TV Settings**” setting, touch on an item in the “**TV Settings**” menu”.

The TV Settings are:

- Channel Guide
- Region
- Default Channel
- Skip Unnamed Channels

Settings	Default	Detail
Channel Guide		Scan Channels
Region	United States	Select the appropriate region for your location.
Default Channel		Set a default channel for the equipment. This is the channel that will display when the TV is turned on.
Skip Unnamed Channels	On	ON/OFF

Channel Guide

The following procedure discusses how to set up the channel guide and how to configure audio and video playback.

Note: The correct region must be set before you scan for available channels. To confirm the settings, touch “**Region**”, a list of regions will be displayed. Confirm that the radio button next to the appropriate region for your area is selected. If the highlighted region is incorrect, touch on the radio button next to appropriate region. Touch “**OK**”, and then touch ◀ **BACK** to the TV Settings menu.

To scan for available channels:

1. Touch Channel Guide from the TV Settings menu.
2. Touch Scan Channel.

The console scans for available channels and when the scan is finished all available channels will be displayed on the screen.

To delete a channel from the Channel Guide:

1. On the Channel Guide screen, touch the listing for the channel you want to delete.
2. Touch the “**DELETE**” button.
3. When asked “Are you sure?” verify that you want to proceed, then touch “**YES**”.
4. Touch ◀ **BACK** to Settings. Procedure 3.1.

Procedure 3.10- P80 – Workout Limits

The Workout Limit settings give you control over how the equipment is used. Use these settings to create reasonable limitations for equipment usage including speed, incline, resistance, and duration.

1. Refer to Procedure 3.1 – Settings, to access the Workout Limits menus.
2. To select a **“Workout Limits”** setting, touch on an item in the **“Workout Limits”** menu”.

Workout Limits Settings			
Settings	Settings Options	Default Fault	Configure/View/Test
Maximum Workout Duration	Use the on-screen keypad or the up and down arrows to enter the maximum workout duration allowed on this fitness equipment.	60 minutes	<ol style="list-style-type: none"> 1. Touch “Maximum Workout Duration” 2. The on-screen keypad will appear, enter the desired duration using the keypad. If an error was made while typing in the duration number, press the back space key “◀” key on the keypad to delete the last entry. Touching the “◀” also reactivate the presets after typing a number on the keypad. 3. Touch “FINISH” to exit to the Workout Limits screen.
Maximum Pause Time	<ul style="list-style-type: none"> • 1 second • 5 seconds • 15 seconds • 30 seconds • 60 seconds • 120 seconds • 300 seconds 	30 seconds	<ol style="list-style-type: none"> 1. Touch “Maximum Pause Time”. 2. Touch on a radio button next to the desired time, a dot will then fill the radio button next to the selection. 3. Touch “OK” to exit to the Workout Limits Settings menu.
Summary Time Out	<ul style="list-style-type: none"> • No Time Out • 30 seconds • 60 seconds • 120 seconds 	60 seconds	<ol style="list-style-type: none"> 1. Touch “Summary Time Out”. 2. Touch on a radio button next to the desired time, a dot will then fill the radio button next to the selection. 3. Touch “OK” to exit to the Workout Limits Settings menu.

Workout Limits Settings Continued			
Settings	Settings Options	Default Fault	Configure/View/Test
Resistance Range (RBK, UBK only)	<ul style="list-style-type: none"> Low Medium High 	Medium	<ol style="list-style-type: none"> Touch "Resistance Range" Touch on the radio button next to Low, Medium, or High, a dot will fill the radio button next the selection. Touch "OK" to exit to the Display menu.
Speed Limit (TRM only)	1-16 mph	16 mph	<ol style="list-style-type: none"> Touch "Speed Limit" The on-screen keypad will appear, enter the desired duration using the keypad. Touch "FINISH" to exit to the Workout Limits screen.
Incline Limit (TRM only)	TRM 883 CrossRamp incline range can be set to 0%-15%. TRM 885 CrossRamp incline range can be set to 0% to 15% Note: the incline range is -3% to 15% but the limit can only be set from 0% to 15%	15	<ol style="list-style-type: none"> Touch "Incline Limit" The on-screen keypad will appear, enter the desired duration using the keypad. Touch "FINISH" to exit to the Workout Limits screen.
Auto Stop (TRM only)	<ul style="list-style-type: none"> ON OFF 	ON	<ol style="list-style-type: none"> Touch "Auto Stop" Touch on a radio button next to either ON/OFF, a dot will then fill the radio button next to the selection. Touch "OK" to exit to the Workout Limits menu.
CrossRamp Auto Level (EFX only)	CrossRamp Auto level settings are from 1% to 20%	1	<ol style="list-style-type: none"> Touch "CrossRamp Auto Level" Touch the "▲, ▼" to move auto level to the desired setting. Touch "OK" to exit to the Workout Limits menu.

3. Touch **BACK** to Settings. Procedure 3.1.

Procedure 3.11 – P80 – Manage Settings (Cloning)

The only P80 console settings that can be imported and exported through a USB Flash Drive device at this time are:

Settings that Can Be Cloned	
Menu	Settings
Display	<ul style="list-style-type: none"> • Measurement of Units • Standby Mode Delay • Time Zone • Closed Captioning • Language
Workout Limits	<ul style="list-style-type: none"> • Maximum Workout Duration • Maximum Pause Time • Summary Time Out • Resistance Range (RBK, UBK only) • Speed Limit (TRM only) • Incline Limit (TRM only) • Auto Stop (TRM only) • CrossRamp Auto Level (EFX only)
TV Settings	<ul style="list-style-type: none"> • Channel Guide • Region • Default Channel • Skip Unnamed Channels
Network Settings	<ul style="list-style-type: none"> • Primary DNS - Manual only • Secondary DNS - Manual only • Gateway - Manual only • Netmask - Manual only
Connectivity	<ul style="list-style-type: none"> • Network Type • Preva Server Address

The following procedure will explain how to save existing P80 console settings onto a USB Flash Drive and then import the saved settings into another P80 console.

Note: Settings from one P80 console will need to be configured manually and imported to a flash drive device before cloning and exporting to additional P80 consoles.

Procedure

1. The “Welcome” screen will be the first screen you see when you approach the P80 console. Press the Pause key and continue holding it down while you **double press (prior to 1.1 version software release)** or **single press (1.1 version or after software release)** in sequential order an X configuration on the Volume and Channel key pad (① Channel Up, ② Volume Down, ③ Volume Up, ④ Channel Down). **See Diagram 3.1.1.** Release the Pause key when done pressing the arrows. **Note: The keypad X configuration sequence should be not faster than 1 second between each key stroke.** Any speed faster than 1 second may result in an unsuccessful access to the sign-in screen.

Diagram 3.11.1



Volume & Channel Key Pad

Pause Button

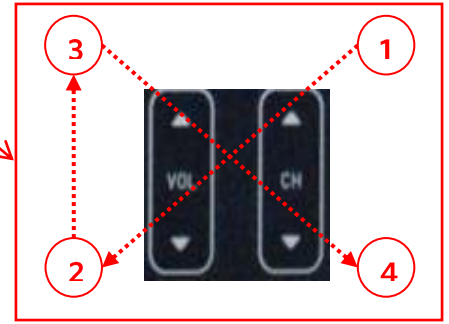

2. The sign-in screen will be displayed. Type in the technician access code and press enter.
3. The "Settings" screen will be displayed. Select "Systems Settings" from the "Settings" menu.
4. From the "Systems Settings" menu select "Manage Settings".
5. The "Manage Settings" screen will display two gray inactive USB Flash Drive Icons. **See Diagram 3.11.2.**

Diagram 3.11.2



6. Insert the USB Flash Drive into the USB Drive Port of the P80 console. **See Diagram 3.11.3.**

Diagram 3.11.3



7. When the gray inactive "Save to USB" Flash Drive Icon becomes active and lights up, select "Save to USB". **See Diagram 3.11.4**

Note: Depending on the type of Flash Drive device used, it may take up to a minute for the USB Flash Drive Icons to become active (light up) after the USB Flash Drive device has been inserted into the P80 console.

Diagram 3.11.4



8. You will see a scrolling in process bar and then "Settings exported successfully to the USB drive" displayed. **See Diagram 3.11.5**
9. Touch "OK" to return the Settings menus.

Diagram 3.11.5



10. The settings export is now complete and you can exit the service mode by touching the back arrow until you get to the "Welcome" screen.
11. Move the USB Flash Drive device with the saved settings to a P80 console that you would like to import the saved settings.
12. Access the "Manage Settings" screen by following the described steps 1 through 9.
13. Insert the USB Flash Drive into the USB Drive Port of the P80 console. **See Diagram 3.11.3.**
14. Wait for the USB Flash Drive Icons to become active (light up) and then select "Import from USB". **See Diagram 3.11.6**

Diagram 3.11.6



15. You will see a scrolling in process bar and then "Settings imported successfully" displayed. **See Diagram 3.11.7**
16. Touch "OK" to return the Settings menus.

Diagram 3.11.7



17. Exit the service mode as described in steps 14.
18. Repeat the described process steps 11 through 16 for any remaining P80 consoles.

Procedure 3.12 – P80 – Replacing the Console

Required Tools

- 2- 7/16 in open end wrenches
- 1/4-inch hex wrench
- SAE 5/32-inch hex wrench
- SAE 1/2-inch box-end wrench
- #2 Phillips screwdriver
- Wire cutter

Procedure

1. Remove the rear vent cover. Do not use a sharp tool, such as a flat bladed screwdriver, to pry up the cover, as you can damage the covers and possibly components inside the console. When the cover starts to come loose, gently unsnap it from the P80 and set it aside where it will not be scratched. **See Diagram 3.12.1**

Diagram 3.12.1

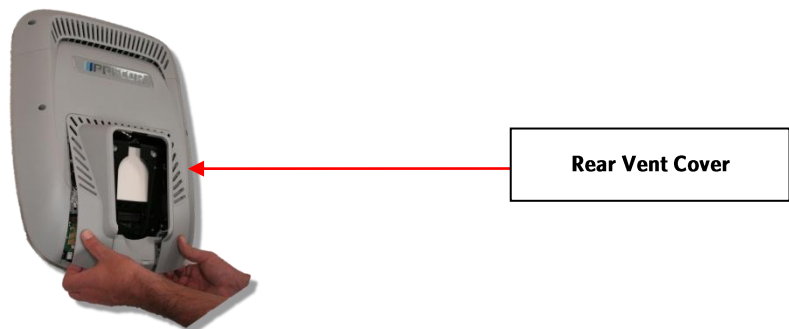

2. Remove the four flat head 5/8 inch long screws that secure the console to the plate. **See Diagram 3.12.2**

Diagram 3.12.2

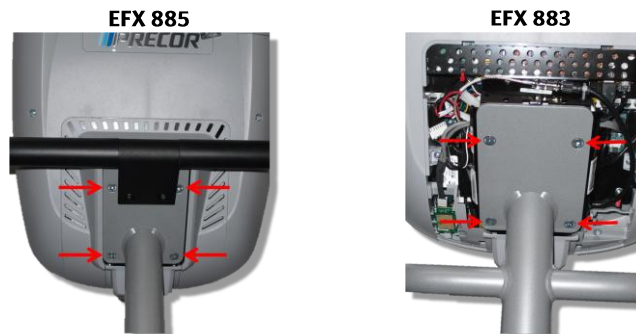

3. Tilt the console forward (away from yourself) on the mounting hook. **See Diagram 3.12.3**

Diagram 3.12.3

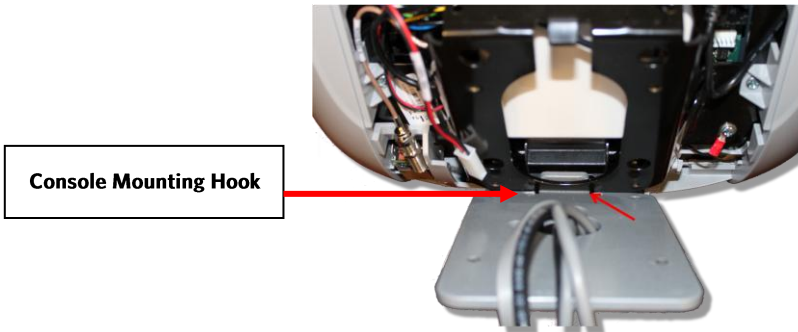

4. Locate the coax connector and cut the wire tie that secures the coax connector to the console armor. Disconnect the coax cable connector from the consoles flexible coax cable connector. **See Diagram 3.12.4**

Diagram 3.12.4

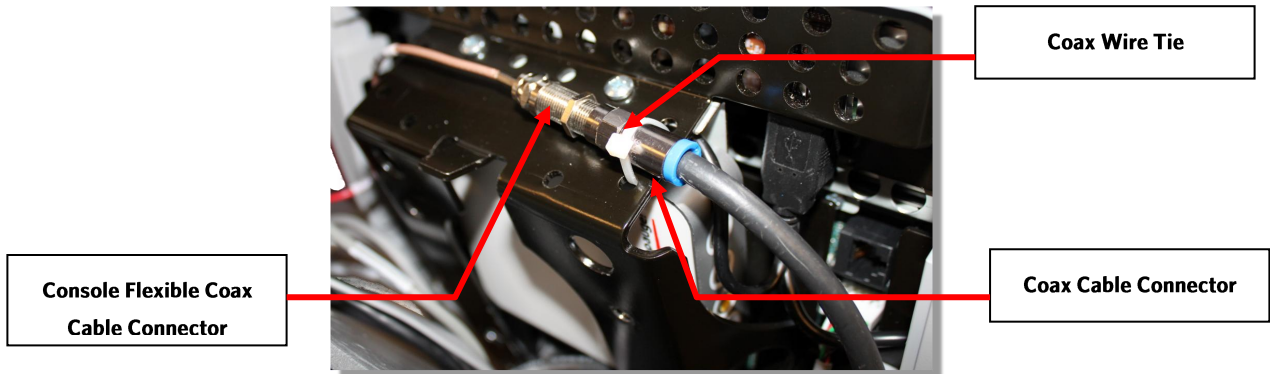

5. Disconnect the Ethernet cable, Data cable, the Power cable and the HR cable. **See Diagram 3.11.5**

Diagram 3.12.5

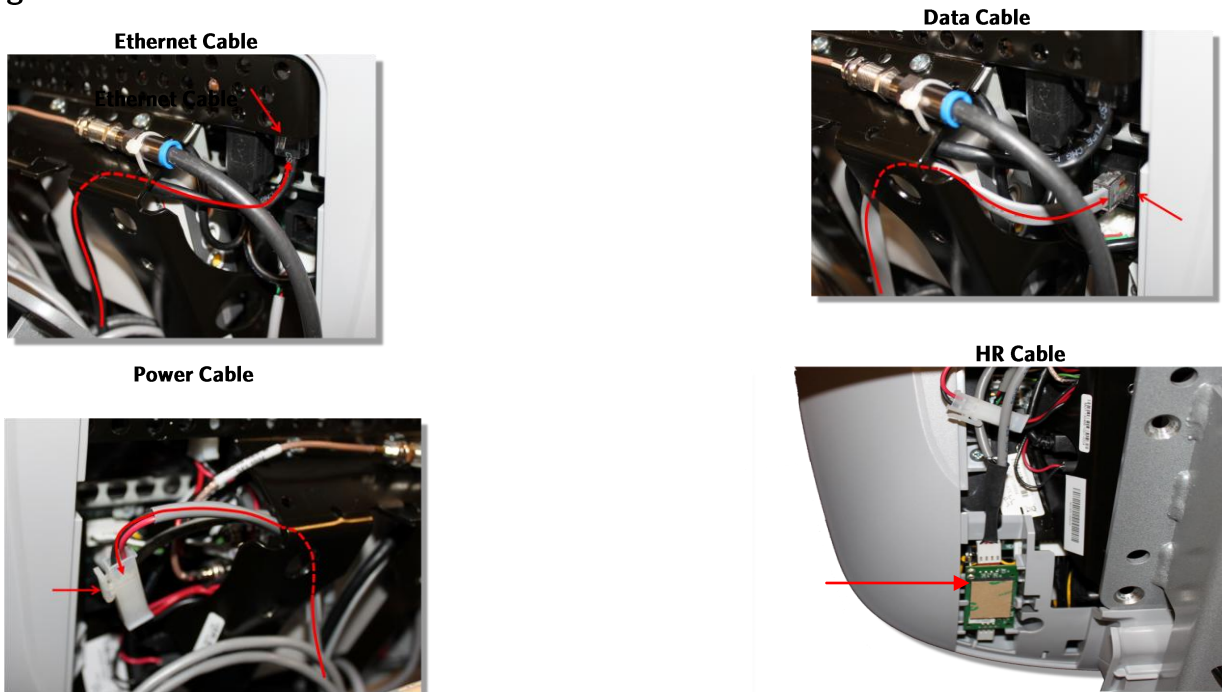

6. Remove the console by lifting it off the mounting hook.
7. Install the replacement console. In the back of the P80 console there is a large black steel support called the Armor. At the bottom of Armor there is a notch about $\frac{1}{4}$ inches in depth and about $1\frac{1}{2}$ inches across. **See Diagram 3.12.6.** Set the console notch over the over the mounting hook. **Note:** Before releasing the console insure the notch is securely seated over the mounting hook. **See Diagram 3.12.4**

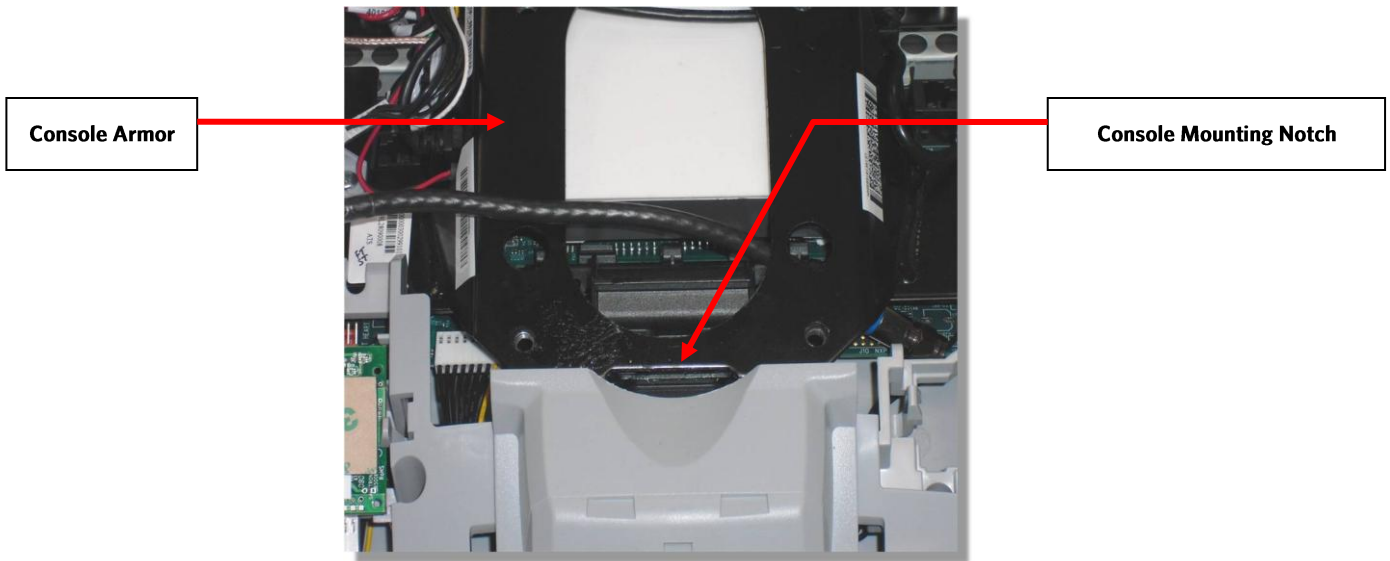
Diagram 3.12.6

8. Route the RF coax cable down below the tuner and out the right bottom side of the armor. This is easier if you straighten the cable and gently push it in the direction as shown in diagram 3.11.7. Feed about 10 inches of cable out though the plastic using your finger as a guide.
9. Bring the coax cable up over the top of the armor and connect it to the flexible cable attached to the tuner. **See Diagram 3.12.8.**
10. Secure the RF coax connectors in place with a zip tie. **Note:** It is important that the connection be tied to the frame in this location to prevent the cable from being pinched, and the possibility of rattling noises during use. Be sure to secure the zip tie on the connector and not on the cable. **See Diagram 3.12.9.**

Diagram 3.12.7

Diagram 3.12.8

Diagram 3.12.9

11. Route the black, round Ethernet cable through the opening in the upper right side of the armor, behind the tuner and connect the Ethernet cable to the upper RJ45 type connector. **See Diagram 3.12.10.**
12. Route the grey, flat Data cable through the opening in the upper right side of the armor, behind the tuner and connect the Data cable to the lower RJ45 type connector. **See Diagram 3.12.11.**

Diagram 3.12.10

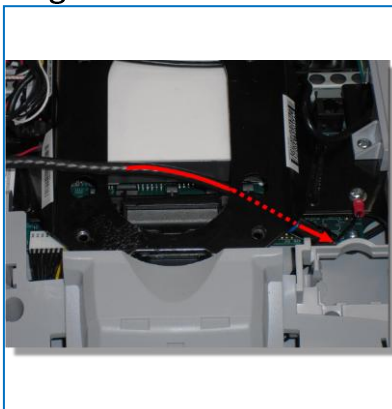
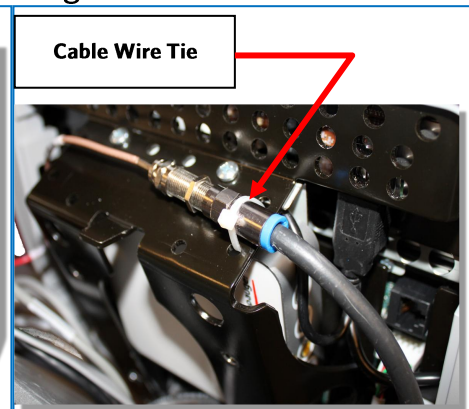
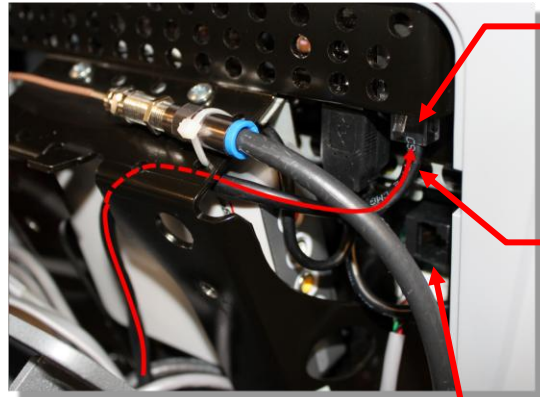
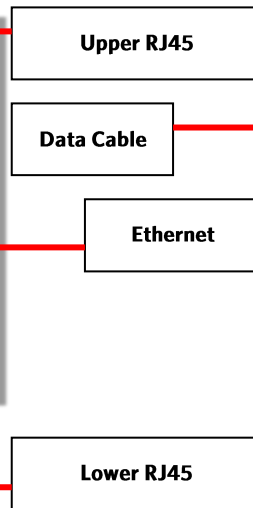
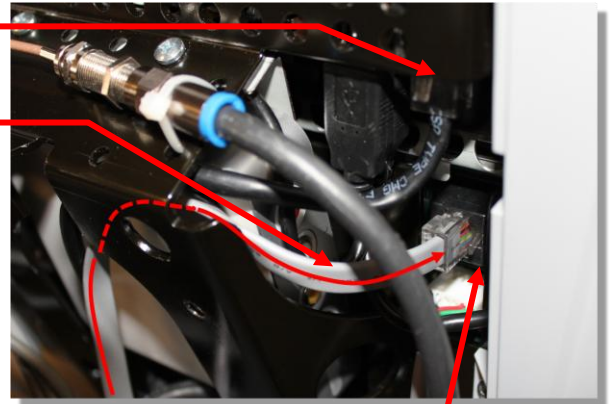
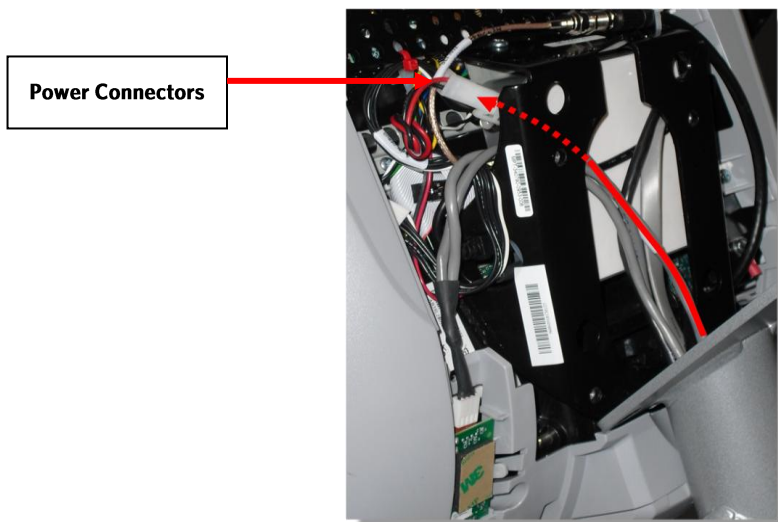
Diagram 3.12.11

13. Route the Power cable through the upper left corner of the weldment and connect it to the P80 power connector. **See Diagram 3.12.12.** **Note:** Leave the connector on the side of the P80 as shown in **diagram 3.12.12**, as it might be necessary to access it for troubleshooting.

Diagram 3.12.12

14. Route the Heart Rate cable through the upper left corner of the weldment and connect it to the HR PCA. Route any excess Heart Rate cable into the rectangular center section of the dash assembly. **See Diagram 3.12.13**

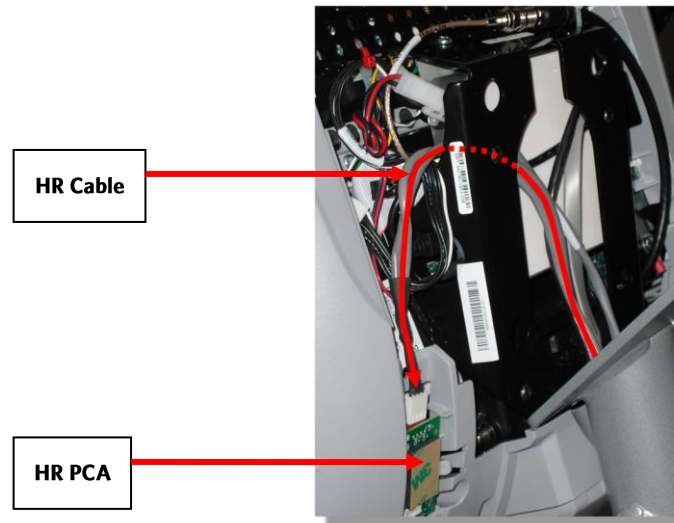
Diagram 3.12.13



15. Make sure that all cables are fully and securely connected, and that cables are tied back properly. Make sure any extra cabling is pulled down through the neck and along the front of the dash, making sure the cables are routed through the plastic guides inside the neck.
16. Tilt the control console backward (toward yourself) until the tab on the top edge of the armor slides along the top edge of the console mount and the screw holes align properly.
17. Secure the console to the plate using the four flat head $\frac{5}{8}$ inch long screws. **Note:** You must use $\frac{5}{8}$ inch long screws. If the screws are too short the console will not be properly grounded. If the screws are too long it is possible to damage the internal wiring.
18. Tighten the screws fully using a $\frac{5}{32}$ -inch hex wrench.
19. Replace the rear vent cover.

Procedure 3.13 – P80 – Replacing the Heart Rate PCA Board

Procedure

20. Remove the rear vent cover. Do not use a sharp tool, such as a flat bladed screwdriver, to pry up the cover, as you can damage the covers and possibly components inside the console. When the cover starts to come loose, gently unsnap it from the P80 and set it aside where it will not be scratched. **See Diagram 3.13.2**

Diagram 3.13.2

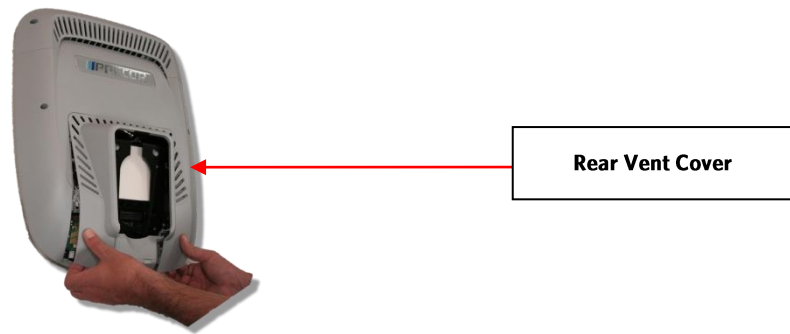

21. The PCA's in the console are static sensitive. They can be damaged if proper static prevention equipment is not used. Attach an anti-static wrist strap to your arm, and then connect the ground lead of the wrist strap to frame ground.
22. The HR PCA snaps into its mounting. Press the release tab sideways and remove the HR PCA from its mounting.
23. Disconnect the HR cable and handlebar cable from the HR PCA. **See Diagram 3.13.3.**
24. Connect the HHR Grip cable assembly to the upper connector on the HR PCA and the HR PCA Power cable to the lower connector on the replacement HR PCA. **See Diagram 3.13.3.**
25. Orient the replacement HR PCA so that the side with the protective foam pad is facing out and snap the HR PCA into its mounting.

Diagram 3.13.3

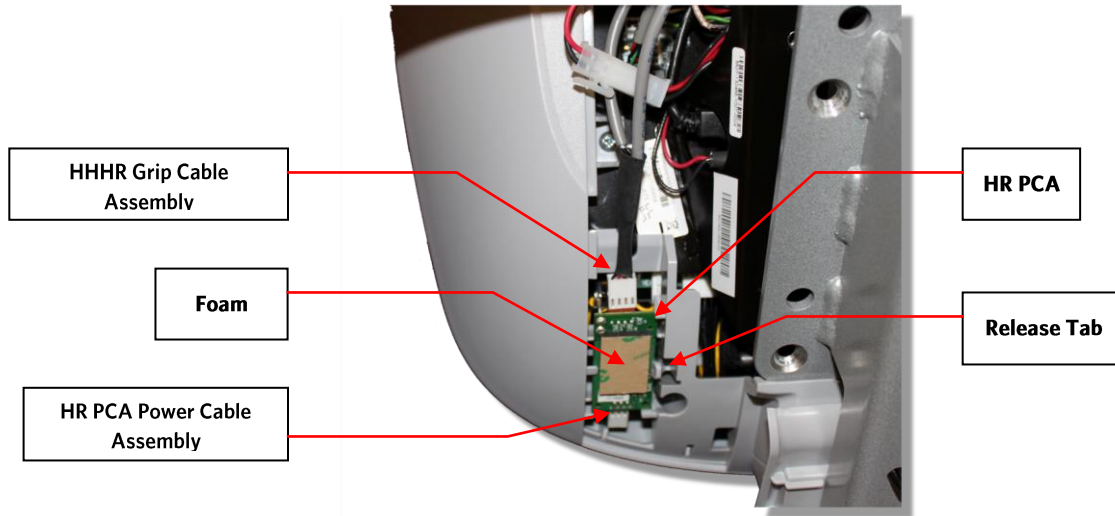

26. Replace the rear vent cover.
27. Check operation per Section 7.

Procedure 3.14 – P80– Future Content

Procedure 3.15 – P80– Future Content

Procedure 3.16 – P80– Future Content

Procedure 3.17 – P80– Future Content

Procedure 3.18 – P80– Future Content

Procedure 3.19 – P80– Future Content

Troubleshooting 3.20- P80 - Black Screen - TV Only

Description

The console interface and the fitness equipment operates normally when using workout programs, but TV channels only display as a black screen and audio is not present.

Possible Causes

1. There is no TV signal to the console
 - a. External jumper cable is damaged or disconnected
 - b. Coax cables inside the unit are damaged or disconnected
 - c. All cables are good and connected but there is no signal at the drop
2. TV channel is not being received or is not a valid channel
3. USB cable connecting tuner to screen is loose or plugged in incorrectly
4. Media player has failed (software)
 - a. Watchdog may or may not be recovering the media player automatically
5. There may be a software mismatch between the CPA and the MFE.
6. Tuner has failed (hardware).

Diagram 3.20.1

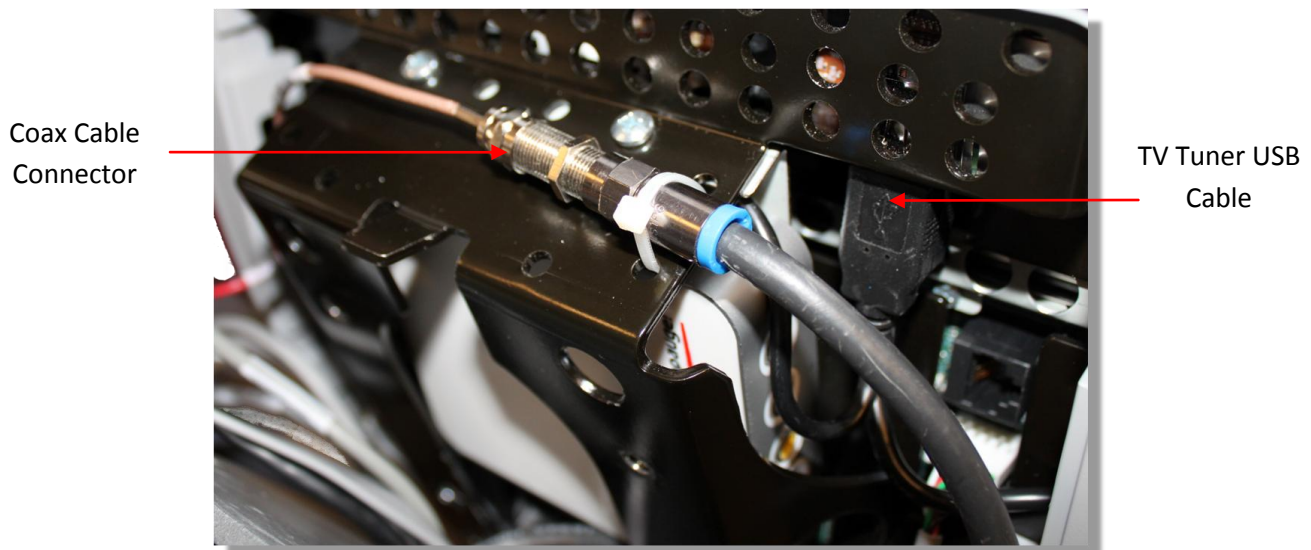

Possible Remedies

1. Check for video signal to the tuner
 - a. Inspect jumper cables connecting fitness equipment to the video drop. If it is visibly damaged or disconnected, replace or reconnect. If it passes visual inspection, swap with a known good. If TV channel now appears, the cable is the cause. Replace the jumper cable. If the channel does not appear, perform the same check on the F connectors.
 - b. Inspect the cable that runs from the patch panel at the bottom of the machine to the console. If this is disconnected or damaged, reconnect or replace. If the cable passes visual inspection, use a known good cable to bypass this cable. If the TV channel appears, replace the coax cable running through the machine.
 - c. Connect the machine to a known good A/V drop. If the TV channel now appears on the console, verify the drop is good. If not, have the customer contact their A/V service technician to repair the drop. Getting a signal strength reading can assist in diagnosing the video problem.
2. Verify on other machines that this is a valid channel. If a channel would appear as total snow or static (as on a channel that is has no signal), then the console will display this as a black screen for that channel. If no machines receive this channel, it is likely that it is not a valid channel. The club's channel lineup may have changed or something may be wrong with their head end.
 - a. If the lineup has changed, rescan to pick up the correct channel lineup. If other units in the facility also have the incorrect lineup, you will need to export this new scan information to the other units.
3. Inspect the black USB cable running from the left side of the tuner to the USB jacks on the right side of the console. The tuner cable must be plugged into the correct jack. If it is not plugged into the outermost jack (the one closest to you when looking at the back of the console) plug it into the correct jack. **See Diagram 3.20.1**
4. If the signal to the console is good and the TV screen has been black for more than 5-10 minutes, then the watchdog is not able to recover the media player. If it is less than 5 minutes or so, the watchdog may still be trying to automatically recover the system.
 - a. This can be verified by looking in the Event Log. Messages that indicate a media reboot include: "Rebooting the meda ," "The mediaapp restart is near," "i2c timeout," or "The OMAP board was rebooted because the mpaqtapp was not running," though this is not inclusive of all possible messages.
 - b. Rebooting the machine will force the media player to reboot. If the TV channel appears after rebooting, the issue was the media player. Verify all channels and operation of unit. If the channel is still black, then verify all other components are operational.
5. Some older versions of software can experience a bug where only one component reverts back to a different image. If the old image is of a much older version of software, this could cause some communications problems between the CPA and the MFE. Open the Settings menu and select Reflashing. Check the version numbers in the CPA Reflashing and the MFE Reflashing menus to make sure they are the correct version numbers. If they are not or say <UNKNOWN>, then this bug may have occurred. Try rebooting the unit to see if it resolves the issue. If not, use the appropriate Reflashing menu to boot that component to the other boot image. Verify that the new image contains the correct software versions.
6. If the video signal can be verified up to the tuner, connect a known good signal directly into the mini-coax on the tuner. If the channel lineup on the console has been confirmed correct, the signal is good, the unit has been rebooted, the software is correct on all components, and the screen is still black, the tuner has likely failed. Replace the entire console.

Troubleshooting 3.21- P80 - Black Screen – Full Console

Description

Console displays only a black screen. Machine is unusable.

Possible Causes

1. Console has frozen
2. Console is attempting to boot to an image that has corrupted
3. Touch screen has failed

Possible Remedies

1. Reboot the machine to resolve any software freezing issues.
2. If the console is attempting to boot to a corrupted software image, when a reboot is performed, the CPA version number will scroll across the display of the machine controls, but the screen will remain black and will never reach the Precor splash screen. Perform a 7 Power Cycle (**See Boot Screen Procedure below**) to force the machine to revert to the backup image. When the unit boots successfully, reflash the unit with the correct software to ensure that the old, corrupted image has a usable image installed.
3. If the touch screen has failed, the entire console will need to be replaced.

Boot Screen Procedure

1. Turn the power off then back on. On treadmills, turn the on/off switch to the “off” position then back to the “on” position. On self powered units, disconnect the power source connected to the P80 console and then reconnect the power source.
2. Wait 15 seconds. It is critical that the timing be no less than 15 seconds and no greater than 45 seconds for the procedure to be successful.
3. **Repeat steps 1 and 2 for 6 additional power “Off and On” cycles.**
4. On the last or 7th cycle leave the power connected or the power switch turned to the “On” position allowing the P80 console to boot up completely.
5. If the P80 console boot up to the “Welcome” screen was successful, go to step 6. If the P80 console still will not boot to the “Welcome” screen contact PRECOR customer support.
6. Reprogram the P80 console with the most current software package available. **See Procedure 3.5, P80 Updating Software**, for instructions on how to reprogram the P80 console.

Troubleshooting 3.22- P80 – Poor Quality Video – Single Unit Only

Description

Television signal is present, but picture quality is consistently or inconsistently poor across all available channels.

Possible Causes

1. Loose or damaged coaxial cable
2. Poor television signal to the machine
3. Incorrect region setting in channel settings

Possible Remedies

1. Check for good video signal to the tuner.
 - a. Inspect jumper cable connecting fitness equipment to the video drop. If it is visibly damaged or disconnected, replace or reconnect. If it passes visual inspection, swap with a known good jumper cable. If a TV channel now appears, the cable is the cause. Replace the jumper cable. If the channel does not appear, perform the same check on the F connectors.
 - b. Inspect the cable that runs from the patch panel at the bottom of the machine to the console. If this is disconnected or damaged, reconnect or replace. If the cable passes visual inspection, use a known good cable to bypass this cable. If the TV channel appears, replace the coax cable running through the machine.
 - c. Connect the machine to a known good A/V drop. If the TV channel now appears on the console, verify the drop is good. If not, have the customer contact their A/V service technician to repair the drop.
 - d. Verify signal strength with signal meter.
2. As above, verify condition and connections of coax cables as well as verify quality of signal to that drop. Verify signal strength with signal meter.
3. Enter the Settings Menu. Select System Settings, then TV Settings. Verify that unit is set for "United States." **See Procedure 3.9. TV Settings.**

Troubleshooting 3.23 - P80 – Poor Quality Video – All Units

Description

Television signal is present, but picture quality is consistently or inconsistently poor across all available channels.

Possible Causes

1. Loose or damaged coaxial cable at or near head end.
2. Poor television signal from head end.
3. Poor television signal to club.
4. All machines were configured using incorrect region setting.

Possible Remedies

1. Verify condition and connections of video distribution network. Begin as close to head end as possible and check for visible damage to coaxial cables or connectors. Verify all connections are tight.
2. Check signal quality and strength as close to head end as possible. If poor from the head end have customer contact their A/V service company to ensure signal from head end is within acceptable parameters.
3. Troubleshoot as above. Signal provider (e.g. Cable Company, Satellite Company, etc.) will need to address this issue.
4. Enter the Settings Menu. Select System Settings, then TV Settings. Verify that unit is set for “United States.”. **See Procedure 3.9. TV Settings.**

Troubleshooting 3.24 - P80 – Poor Quality Video – One Channel(s) or Limited Channels

Description

One or a limited number channels on a unit has poor reception or no reception.

Possible Causes

1. Loose or damaged coaxial cable.
2. Poor television signal to the machine.
3. Incorrect channel scan lineup.

Possible Remedies

1. Check for good video signal to the tuner.
 - a. Inspect jumper cable connecting fitness equipment to the video drop. If it is visibly damaged or disconnected, replace or reconnect. If it passes visual inspection, swap with a known good jumper cable. If the TV channel now appears, the cable is the cause. Replace the jumper cable. If the channel does not appear, perform the same check on the F connectors.
 - b. Inspect the cable that runs from the patch panel at the bottom of the machine to the console. If this is disconnected or damaged, reconnect or replace. If the cable passes visual inspection, use a known good cable to bypass this cable. If the TV channel appears, replace the coax cable running through the machine.
 - c. Connect the machine to a known good A/V drop. If the TV channel now appears on the console, verify the drop is good. If not, have the customer contact their A/V service technician to repair the drop.
 - d. Verify signal strength with signal meter.
2. As above, verify condition and connections of coax cables as well as verify quality of signal to that drop. Verify signal strength using a signal meter.
3. Rescan channels on that unit. This is less likely to be the problem if the channel is coming in poorly since if the console is looking at the wrong channel number entirely, this should manifest as a black TV screen rather than poor video quality.

Troubleshooting 3.25 - P80 - Green Screen

Description

Entire touch screen is displaying a green color. No response to any inputs, machine is completely unusable.

Possible Causes

1. Operation System, kernel crash. Operating System is completely hung up, no error logging is able to occur.

Possible Remedies

1. Reboot machine.

Troubleshooting 3.26 - P80 – Stuttering Channels

Description

TV channels stutters and skips regularly every second or so. Video and audio skip together. If the skipping channel is left on, the TV may go black for a short time and the mediaapp will be reset by the system.

Possible Causes

1. Tuner tuned improperly to the channel

Possible Remedies

Change the channel to a different channel. The skipping will now be gone and the user can change back to the original channel.

Troubleshooting 3.27 - P80 – Touch Screen Unresponsive

Description

Touch screen does not respond to any touches. Screen may show a static or a moving image, but is not completely black.

Possible Causes

1. Console was improperly calibrated or has fallen out of calibration
2. Console has locked up.
3. Touch Screen is defective

Possible Remedies

1. Use Single Secret Handshake to enter screen calibration. **See Single Secret Handshake Procedure below.** Press each 'X' in sequence to recalibrate the screen. **See Procedure 3.6, Systems Test.** Ensure the person recalibrating is standing on the machine and is not holding on to the console or any other part of the machine while doing so.
2. Reboot the machine
3. If touch screen has failed entirely, console will need to be replaced. This is not a replaceable part.

Single Secret Handshake Procedure

Press the Pause key and continue holding it down while you press in sequential order an U configuration on the Volume and Channel key pad (① Channel Up, ② Channel Down, ③ Volume Down, ④ Volume Up). **See Diagram 3.27.1.** Release the Pause key when done pressing the arrows. **Note: The keypad U configuration sequence should be not faster than 1 second between each key stroke.** Any speed faster than 1 second may result in an unsuccessful access to the sign-in screen.

Diagram 3.27.1



Volume &
Channel Key Pad

Pause Button

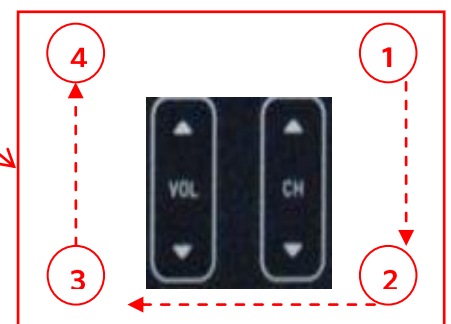

Troubleshooting 3.28- P80 – Touch Screen Slow Response

Description

Touch screen responds appropriately to touches, but does so slowly. The screen may or may not play the animations associated with the touches when carrying out the appropriate action.

Possible Causes

1. The console is running low on memory.

Possible Remedies

1. Reboot the console. This will clear the memory and restore the unit to normal operation.

Troubleshooting 3.29 - P80 – Touch Screen Responds Incorrectly to Touch

Description

Touch screen reads touches, but it is not registering them where the user is touching the screen.

Possible Causes

1. The touch screen was improperly calibrated or has fallen out of calibration.

Possible Remedies

1. Use Single Secret Handshake to enter screen calibration. **See Single Secret Handshake Procedure below.** Press each 'X' in sequence to recalibrate the screen. **See Procedure 3.6, Systems Test.** Ensure the person recalibrating is standing on the machine and is not holding on to the console or any other part of the machine while doing so.

Single Secret Handshake Procedure

Press the Pause key and continue holding it down while you press in sequential order an U configuration on the Volume and Channel key pad (① Channel Up, ② Channel Down, ③ Volume Down, ④ Volume Up). **See Diagram 3.27.1.** Release the Pause key when done pressing the arrows. **Note: The keypad U configuration sequence should be not faster than 1 second between each key stroke.** Any speed faster than 1 second may result in an unsuccessful access to the sign-in screen.

Diagram 3.27.1



Volume &
Channel Key Pad

Pause Button

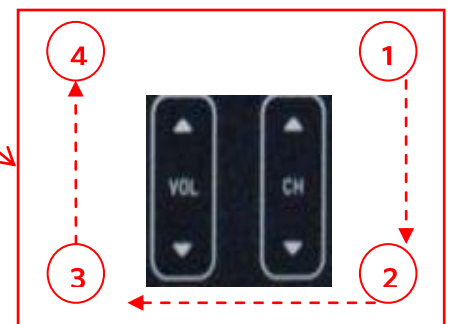

Troubleshooting 3.30 - P80 - Poor Audio Quality - All Channels, One/Limited Units

Description

While video signal is good to one or a few machines, the sound is of poor quality.

Possible Causes

1. Bad or damaged headphone jack
2. Bad or damaged headphone jack cable
3. Poor television signal to the machine

Possible Remedies

1. Remove and inspect headphone jack for damage. If jack passes visual inspection, swap headphone jack with known good.
2. Inspect cables from console to headphone jack. Verify that they are not damaged. If they are, these are not field-replaceable. Console will need to be swapped.
3. Check for good video signal to the tuner. Generally, however, if the issue is a cabling issue, the video will be bad along with the sound. However, if there is an issue with how the amplifier in the head end is configured, this could result in good video, but poor sound, though this is likely to be an issue across all units rather than a subset of the entire facility.

Troubleshooting 3.31 - P80 – Poor Audio Quality – All Channels, Multiple Units

Description

While video signal is good to one or a few machines, the sound is of poor quality.

Possible Causes

1. Bad or damaged headphone jack
2. Bad or damaged headphone jack cable
3. Poor television signal from the head end

Possible Remedies

1. Remove and inspect headphone jacks for damage. If jack passes visual inspection, swap headphone jack with known good.
2. Inspect cables from console to headphone jack. Verify that they are not damaged. If they are, these are not field-replaceable. Console will need to be swapped.
3. Check for good video signal from the head end. Generally, however, if the issue is a cabling issue, the video will be bad along with the sound. However, if there is an issue with how the amplifier in the head end is configured, this could result in good video, but poor sound, though this is likely to be an issue across all units rather than a subset of the entire facility.

Troubleshooting 3.32 - P80 - Machine Controls Unresponsive

Description

Machine controls do not respond to input. User is unable to change workout parameters.

Possible Causes

1. Cable from machine controls to upper board is damaged or not inserted properly.
2. Machine controls have failed

Possible Remedies

1. Check yellow/black cable in console for damage. Ensure the cable is inserted fully onto the pins. If not inserted properly, insert. If cable is damaged, console must be replaced; this is not a replaceable part.
2. If machine controls have failed, the entire console will need to be replaced. This is not a replaceable part.

Troubleshooting 3.33 - P80 - Machine Controls Incorrect Response

Description

Machine controls do not respond properly to input – speed up makes speed go down, incline up makes incline go down, etc.

Possible Causes

1. “Bounce-back” If the user is flipping the machine controls with a lot of force, the control could rebound with enough force to cause it to bounce in the other direction, causing the machine to think the user is actually pressing it in that direction.
2. Cable from machine controls to upper board is damaged or not inserted properly.
3. Machine controls have failed

Possible Remedies

1. Verify the user is not using excessive force on the controls. Test to make sure they are operating properly when appropriate force is used. Educate customer on proper use of equipment.
2. Test controls in Systems Tests. **See Procedure 3.6, Systems Test.** Check yellow/black cable in console for damage. Ensure the cable is inserted fully onto the pins. If not inserted properly, insert. If cable is damaged, console must be replaced; this is not a replaceable part.

Troubleshooting 3.34- P80 – Message “Out of Service” Displayed

Description

Console is displaying a message that says “Temporarily Out of Service. Please use another machine.”

Possible Causes

1. Software has encountered an error causing the console to enter Out of Service mode
2. The Auto Stop sensor on a treadmill is missing, improperly installed, or malfunctioning (Treadmill Only).

Possible Remedies

1. Reboot the console. Most issues causing “Out of Service” errors will be cleared from a reboot.
2. Treadmill Only. Inspect the Auto Stop sensor and ensure it is installed properly. Inspect Auto Stop cable to ensure it is inserted properly and undamaged. Repair or replace if needed. OOS error will clear as soon as the sensor is detected. Do not disable the Auto Stop sensor in the software. For more trouble shooting information on the Auto Stop feature see **Troubleshooting- 9.5 - TRM_ Trouble Shooting the Auto Stop Feature.**

Troubleshooting 3.35 - P80 – Message “Please Reset the Treadmill” Displayed

Description

On a treadmill, the screen displays the message, “Please Reset the Treadmill” along with a graphic of the stop switch.

Possible Causes

1. The Stop Switch lanyard has been pulled and the reset latch has been disengaged. The yellow button will be raised on the dash.
2. The stop switch reset latch has been engaged, but not fully so.
3. The cable connecting the stop switch to the console is disconnected, loose, or damaged.
4. The stop switch is malfunctioning

Possible Remedies

1. Press down firmly the yellow button on the dash. The tread will reset itself shortly.
2. Pull the lanyard to disengage the reset latch. Press down firmly on the yellow button on the dash to reset the treadmill.
3. Inspect the connections leading from the stop switch to the console. Ensure that the cables are secure and undamaged.
4. Replace the stop switch assembly.

Troubleshooting 3.36 - P80 – Unit reboots of its own volition

Description

Console fully reboots without any outside input, either during the boot process or while in operation.

Possible Causes

1. Power connections outside fitness equipment are loose or bad
2. Power connections inside fitness equipment are loose or bad
3. Faulty power supply
4. Facility power is not configured correctly.
5. Faulty console

Possible Remedies

1. Inspect power cord from wall plate to power supply (if non-Treadmill) or patch panel (if Treadmill). Verify all connections are tight and that there is no damage. Swap with known good cable, if appropriate. Inspect connections from power supply to patch panel (if non-Treadmill). Reconnect or replace all cables as needed.
2. Open the machine and inspect the power cord running from patch panel to console (if non-Treadmill) or from patch panel to power supply (if Treadmill). Swap with known good to test, if needed. On Treads, also check from power supply to console. Again, swap with known good to test.
3. Inspect power supply for damage. Swap with known good power supply to test. Replace, if needed.
4. Ensure that facility has configured their power correctly. About 8 non treadmill units can be connected through one dedicated circuit. Each treadmill must be on a dedicated, branch circuit. Neutrals and Hot Leads must not be shared among treadmills. If the power supplied to the machines is not up to specification, the customer will need to contact an electrician to make the needed repairs.
5. If the power, power supply, and power cabling are all good and securely connected, the console will need to be replaced.

Section Four - Future Content

Section Five - P30 Console - EFX



CAUTION: Before beginning any fitness program, see your physician for a thorough physical examination. Seek advice from your physician to learn the target heart rate appropriate for your fitness level. Do not allow children, or those unfamiliar with the operation of this equipment, on or near it. Read the product owner's manual or consult a qualified instructor before operating this equipment. Improper use of this equipment can result in serious injury. If you feel pain, lightheadedness, stop exercising immediately.

MUSCLE MONITOR™



WORKOUTS

- MANUAL
- HEART RATE
- INTERVAL
- WEIGHT LOSS
- VARIETY
- PERFORMANCE

Procedure 5.1 - P30 - Accessing the Diagnostic Software

The P30 Console diagnostic software consists of the following modes:

- Beeper Test
- Display Test
- Keyboard Test
- Heart Rate Test
- Machine Test
 - Brake Test
 - Incline Test
 - RPM Test
 - Battery Test

Procedure:

1. The EFX 883 and 833 uses the standard access codes to provide access to the various software features. Use the **PAUSE** key and the numeric keypad to enter the access code. The standard access codes use all sequential key presses. The allowable delay between key presses is short. If too much time is taken between key presses the access procedure will be aborted. If the access is aborted, it will be necessary to start over from the beginning.

Diagram 5.1 .1 - P30 Console - EFX



2. Using the **PAUSE** key and the numeric keypad, press keys **PAUSE,5,1,7,6,5,7,6,1**, sequentially.
3. **Hardware Validation** will scroll across the display followed by **DISPLAY TEST**.
4. Press the **OK** key, the upper most group of LED's will illuminate on the display. Check the display to ensure that all LED segments are illuminated.
5. Press the **OK** key four more times to display the remaining LED groups. Check each display group to ensure that all LED segments are illuminated.
6. Press the **BACK** key then the **▼** key, **KEYBOARD TEST** will scroll across the display.
7. Press the **OK** key, a representation of all of the keys on the console will be displayed. Pressing a key on the console will cause the illuminated representation of that key to turn off. Press all of the keys on the console to ensure that all of the keys are functioning.
8. Press and hold the **BACK** key for **5 seconds** then the **▼** key, **HEART RATE** will be displayed.
9. Press the **OK** key then grasp both of the heart rate grips on the handlebar, after a couple of seconds the heart rate will be displayed in the heart rate and smart rate displays.
10. Use chest strap transmitter or a test transmitter to test the wireless heart rate function, after a couple of seconds the heart rate will be displayed in the heart rate and smart rate displays.
11. Press the **BACK** key then the **▼** key, **MACHINE TEST** will scroll across the display.
12. You may now proceed to either the belt brake test or the incline test. Press the **▼** key once to access the brake test or twice to access the incline test. Press the **OK** key.
13. **BRAKE** test. Press the **OK** key, the console will display the power bits (PWRB).
14. Press the **BACK** key then the **▼** key, **INCLINE TEST** will scroll across the display.
15. **INCLINE** test. The console will display the analog to digital (A/D) incline position number and the incline position in percent of incline. Press the inline **▲,▼** keys to operate the incline throughout its range.
16. Press the **BACK** key then the **▼** key, **RPM** will scroll across the display.
17. **RPM** test. Press the **OK** key, the console will display the Pulse. The pulse is showing a count of zero crossings from the generator. RPM shows a software averaged version of pulse.
18. Press the **BACK** key then the **▼** key, **BATTERY** will scroll across the display.
19. **BATTERY** test. Press the **OK** key, the console will display the battery test. Battery test will display battery voltage.

20. Press the **BACK** key to exit the belt battery test.
21. Press the **PAUSE** key to exit the hardware validation test.

Procedure 5.2 – P30 – Displaying Information

The information display will access the following data;

- Odometer
- Hour Meter
- U-Boot Software
- U-Base Software
- Lower Software
- Serial Number
- Usage log
- Error Log

Procedure

1. With the **PRECOR** banner scrolling, press the keys **PAUSE,6,5**, sequentially.
2. **DIAGS-INFORMATION DISPLAY** will scroll across the display.
3. Use the **▲,▼** keys to move to the desired display shown in the list above.
4. **ODOMETER** display. Press the **OK** key.
5. The odometer will be displayed as **1234567 MILES** or **1234567 KM** depending on club parameter settings (See Procedure 2.3). The odometer is also used to provide the “distance stamp” for the error code log
6. **Note:** The odometer data is stored in non-volatile memory on the upper PCA. If the upper PCA is replaced the odometer data will be lost.
7. Press the **BACK** key to exit the odometer display.
8. **HOUR METER** display. Press the **OK** key.
9. The operating time of the unit will be displayed as **12345 HOURS**. The operating time is defined as total amount of time that the unit has operated in program modes. The hour meter is also used to provide the “time stamp” for the error code log.
10. Press the **BACK** key to exit the hour meter display.
11. **U-BOOT SW** display. This display the installed version of upper boot software. The boot software is used to upload new software into the upper display PCA.
12. Press the **OK** key. The software part number will be displayed as **XXXXX-XXX**.
13. Press the **BACK** key to exit the U-Boot SW display.
14. **U-BASE SW** display. This display the installed version of upper PCA software.
15. Press the **OK** key. The software part number will be displayed as **XXXXX-XXX**.

16. Press the **BACK** key to exit the U-Base SW display.
17. **LOWER SW** display. This display the installed version of lower PCA software.
18. Press the **OK** key. The software part number will be displayed as **XXXXX-XXX**.
19. Press the **BACK** key to exit the lower SW display.
20. **SER. NUMBER** display. Press the **OK** key.
21. The serial number will be displayed. The serial number may be incorrect or not displayed if the upper PCA has been replaced.
22. Press the **BACK** key to exit the serial number display.
23. **USAGE LOG** display. Press the **OK** key.
24. Use the **▲,▼** keys to move through the list of programs. A message will scroll describing the program, the number of times and the number of minutes the program was used.
25. Press the **BACK** key to exit the usage log display.
26. **ERROR LOG** display. Press the **OK** key, the quantity of errors in the log will be displayed.
27. Press the **OK** key, the most recent error will be displayed first.
28. Use the **▲,▼** keys to move through the list of errors. The error messages will list the error name, the odometer reading when the error occurred, the hour meter when the error occurred and the drive motor current reading when the error occurred.
29. If you wish to clear the error log, press and hold the **QUICK START** key. The message **HOLD TO CLEAR ERRORS** will be displayed. The error log will be cleared when the message **NO ERRORS** is displayed.
30. Press the **PAUSE** key to exit the information display.
31. Please note that the **ERROR LOG** may also be accessed at any time by pressing and holding the **PAUSE** key for four seconds. If the error log does not contain any errors, the message **STUCK KEY** will be displayed.

Procedure 5.3 – P30 – Setting Club Parameters

This procedure allows you to change the following club settings:

- Select Language
- Select Units
- Set Max Workout Time
- Set Max Pause Time
- Set Cool Down Time
- Set Incline Limit

Procedure

1. With the banner scrolling, press keys **PAUSE,5,6,5,1,5,6,5**, sequentially.
2. Use the **▲,▼** keys to move to the desired display shown in the list above.
3. **DIAGS-SET CLUB PARAMETERS** will scroll across the display.
4. **SELECT LANGUAGE** display. Press the **OK** key.
5. Use the **▲,▼** keys to toggle between the available languages.
6. Press the **OK** key to select desired language.
7. Press the **BACK** key to exit the select language display.
8. **SELECT UNITS** display. Press the **OK** key.
9. Use the **▲,▼** keys to toggle between **U.S** (miles per hour) and **METRIC** (kilometers per hour).
10. Press the **BACK** key to exit the set units display.
11. **SET MAX WORKOUT TIME** display. Press the **OK** key.
12. Use the **▲,▼** keys to select the maximum time a user can remain in a program.
13. Press the **BACK** key to exit the set max. workout time display.
14. **SET MAX PAUSE TIME** display. Press the **OK** key.
15. Use the **▲,▼** keys to select the maximum time a program will remain in the pause mode.
16. Press the **BACK** key to exit the set max. pause time display.
17. **SET COOL DOWN TIME** display. Press the **OK** key.
18. Use the **▲,▼** keys to select the cool down time.
19. Press the **BACK** key to exit the set cool down time display.
20. **SET INCLINE LIMIT** display. Press the **OK** key.
21. Use the **▲,▼** keys to select the maximum allowable incline setting.
22. Press the **BACK** key to exit the set incline limit time display.
23. **BACK** to exit without saving changes.

Procedure 5.4 - P30 - Documenting Software Problems

When a problem is found with the software in the upper or lower PCA, record the information listed below.

When a problem occurs, record the following information:

- Model and serial number
- Software version number
- Program number running when the problem occurred

A description of:

- What happened or failed to happen.
- The action taken by the user just before the problem occurred.
- Problem-related information (such as how far into the program the problem occurred, the work level being used when the problem occurred, error code displayed, etc.).
- The frequency of occurrence.

Procedure 5.5 – P30 – Replacing Upper PCA

1. Set the treadmill circuit breaker in the “off” position and unplug the treadmill’s line cord from the AC outlet.
(TRM only)
2. The PCA’s in the console are static sensitive. They can be damaged if proper static prevention equipment is not used. Attach an anti-static wrist strap to your arm, and then connect the ground lead of the wrist strap to the treadmill’s frame ground.
3. Remove the two screws that fasten the dash transition cover and remove the cover. **See Diagram 5.5.1**
Diagram 5.5.1 – Dash Transition Cover – (TRM only)



4. Remove the four screws that fasten the console to the dash mounting plate. **See Diagram 5.5.2.**
5. **Diagram 5.5.2 – Dash Mounting Plate**

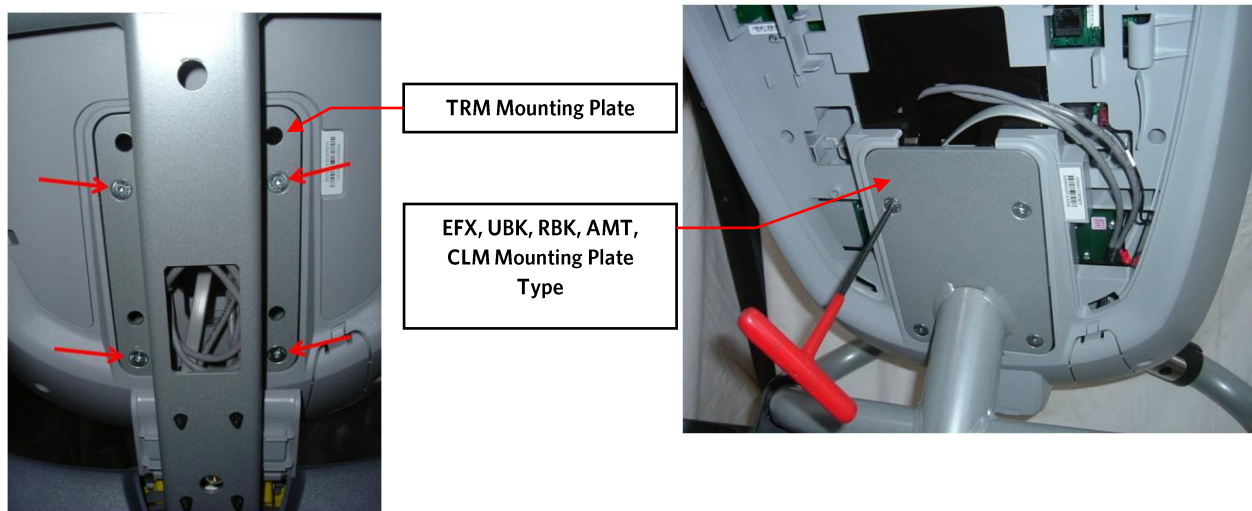

6. Remove the two screws that fasten the access panel to the console. **See Diagram 5.5.3**

Diagram 5.5.3 – Console Access Panel



7. Remove the back access Panel:
 - a. Treadmills: Lift the console off the maintenance hook and then position the console so that the back panel is accessible and remove the back cover.
 - b. AMT's, EFX's, CLM's, UBK's, and RBK's: Tilt the console forward on the maintenance access hook on the dash weldment and remove the back. **See Diagram 5.5.4.**

Diagram 5.5.4 – Maintenance Access Hook

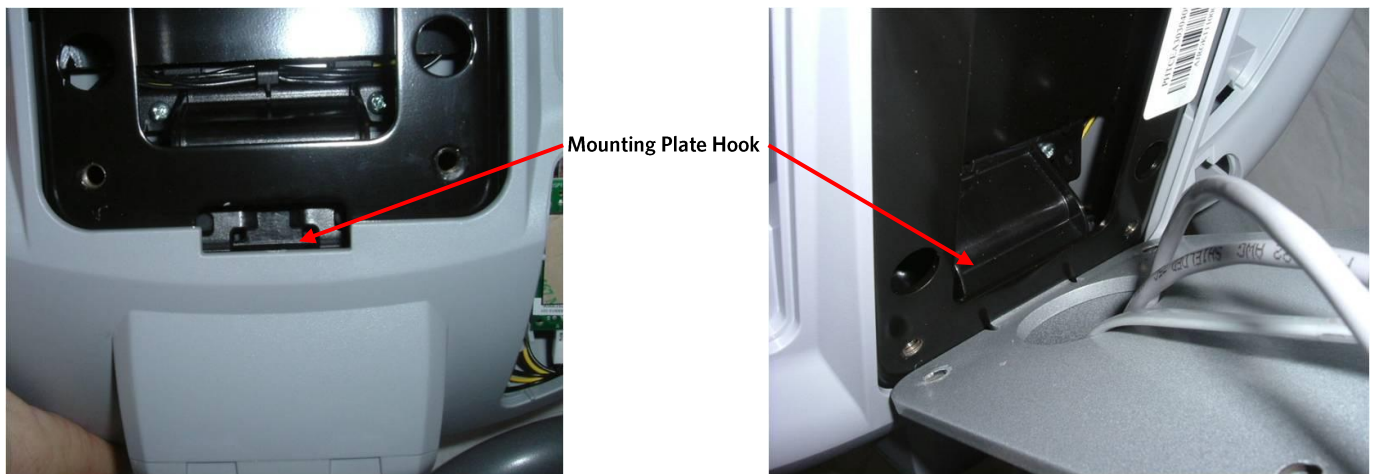

8. Remove the Heart Rate PCA. **See Procedure 5.7, Removing Heart Rate PCA.**
9. Disconnect the Heart Rate Cable from the Heart Rate PCA.
10. Disconnect the Data cable, Auto Stop cable (Treadmill only), Stop Key cable (Treadmill only), Ground wire and the CSAFE cable (if in use) from the Upper PCA. **See Diagram 5.5.5.** Remove the console from the maintenance access hook and place it on a flat work surface.

Diagram 5.5.5 - P30 Cable Connectors

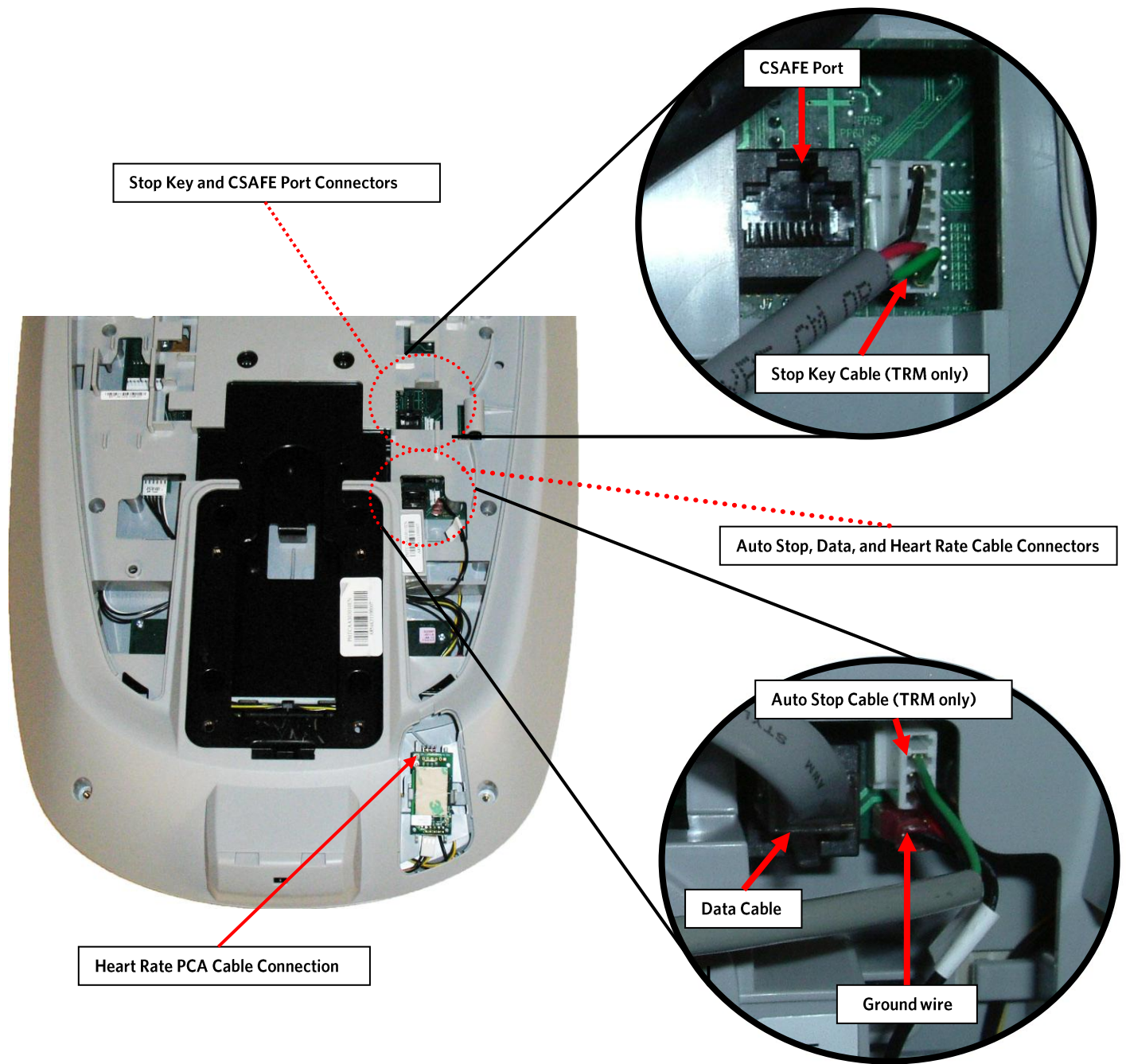

11. Remove the two screws that fasten the back cover to the option cap and remove the cover. **See Diagram 5.5.6**

Diagram 5.5.6 – Option Cap Back Cover



12. Remove the 6 screws that fasten the rear cover from the console and remove. **See Diagram 5.5.7.**

Diagram 5.5.7 – Rear Console Cover

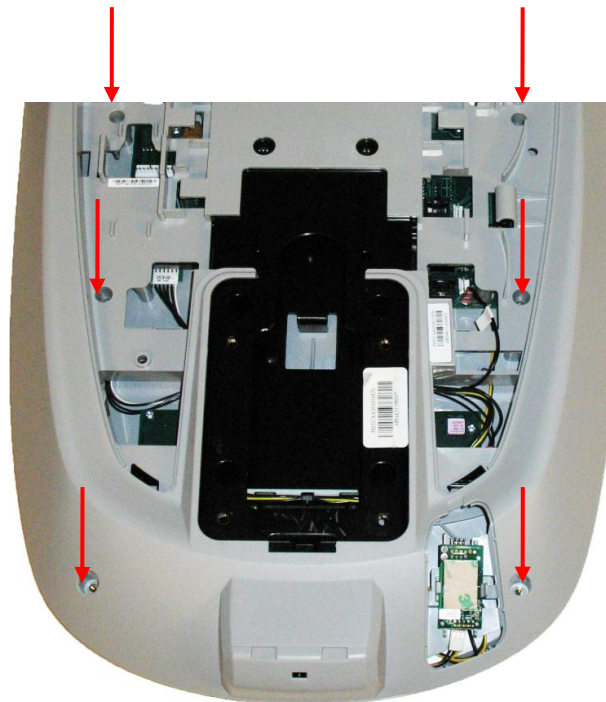

13. Disconnect the Metric cable (J5), Machine Controls cable (J4), Option Cap cable (J6, if applicable), Keypad Metric cable (J9) and HR cable (J10) from the Upper PCA board. **See Diagram 5.5.8.**
14. Remove the five screws that fasten the Upper PCA board to the console and remove the Upper PCA.

Diagram 5.5.8 – P30 Electronic Components

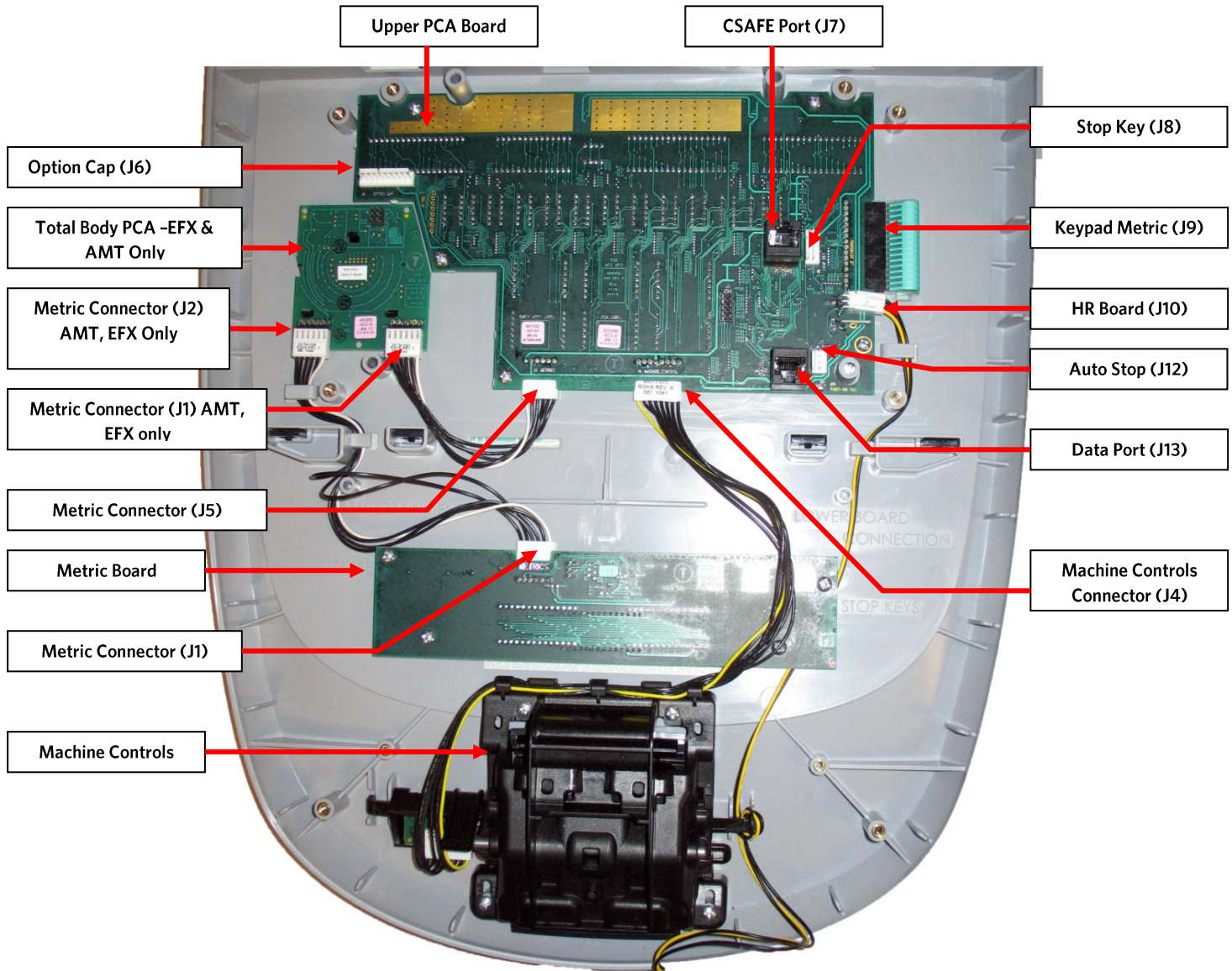

15. Install the replacement upper PCA into the console using the five screws removed in step 14. Torque to 10 inch pounds.

Note: Do not use an electric screw driver or over tighten the screws. Over tightening may damage the console. This type of damage is not covered under warranty.

16. The white wire in the Metrics cable and the yellow wire in the Machine Controls and HR cables indicate pin 1. Align the white wire in the Metrics cable and yellow wires in the Machine Controls and HR cables with the pin 1 markings on the upper PCA. **See Diagram 5.5.9**

Note: If pin 1 is not marked on the Upper PCA refer to **Diagram 5.5.9**.

Diagram 5.5.9 - P30 PCA - Pin 1 Reference

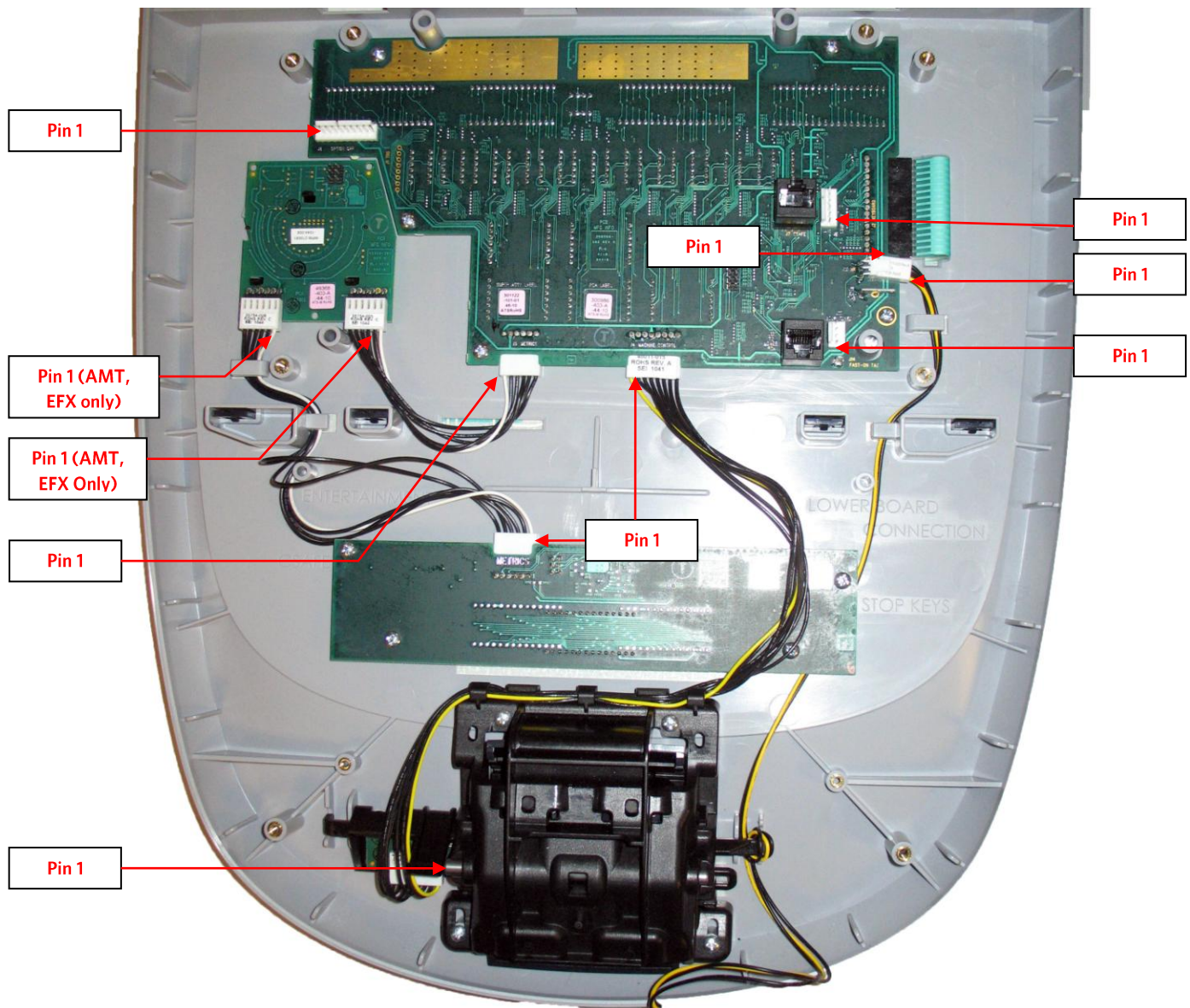

17. Reconnect the Metric cable (J5), Metric cable (J1), Metric cable (J2), Machine Controls cable (J4), Option Cap cable (J6, if applicable), Keypad Metric cable and HR cable (J10) from the Upper PCA board. **See Diagram 5.5.8.** cables to the Upper PCA.
18. Replace the P30 Rear Cover removed step 12 and secure the cover with the screws 6 screws. Torque to 10 inch pounds.
Note: Do not use an electric screw driver or over tighten the screws. Over tightening may damage the console. This type of damage is not covered under warranty.
19. Replace the P30 Option Cap back cover removed step 11 and secure the cover with the screws 2 screws. Torque to 10 inch pounds.
Note: Do not use an electric screw driver or over tighten the screws. Over tightening may damage the console. This type of damage is not covered under warranty.
20. Place the P30 console on the maintenance access hook.
21. Reconnect the Data cable, Auto Stop cable (Treadmill only), Stop Key cable (Treadmill only), Ground wire and the CSAFE cable (if in use) to the Upper PCA. **See Diagram 5.5.5.**
22. Reconnect the Heart Rate Cable to the Heart Rate PCA.
23. Replace the Heart Rate PCA. **See Procedure 5.7, Removing Heart Rate PCA**
24. Replace the access cover with the hardware removed in step 6.
25. Tilt the console back against the mounting plated. While tilting the console back feed the excess cable into weldment tube making sure that the cables will not become pinched.
26. Fasten the console to the dash mounting plate with the four screws removed in step 4. **See Diagram 5.5.2.**
27. Fasten the dash transition cover using the two screws removed in step 3. **See Diagram 5.5.1**
28. Check treadmill operation per Section Seven.

Procedure 5.6 – P30 – Replacing Metric PCA

1. Set the treadmill circuit breaker in the “off” position and unplug the treadmill’s line cord from the AC outlet.
(TRM only).
2. The PCA’s in the console are static sensitive. They can be damaged if proper static prevention equipment is not used. Attach an anti-static wrist strap to your arm, and then connect the ground lead of the wrist strap to the treadmill’s frame ground.
3. Remove the two screws that fasten the dash transition cover and remove the cover. **(TRM Only) See Diagram 5.6.1**

Diagram 5.6.1 – Dash Transition Cover – (TRM only)



4. Remove the four screws that fasten the console to the dash mounting plate. **See Diagram 5.6.2.**

Diagram 5.6.2 Dash Mounting Plate

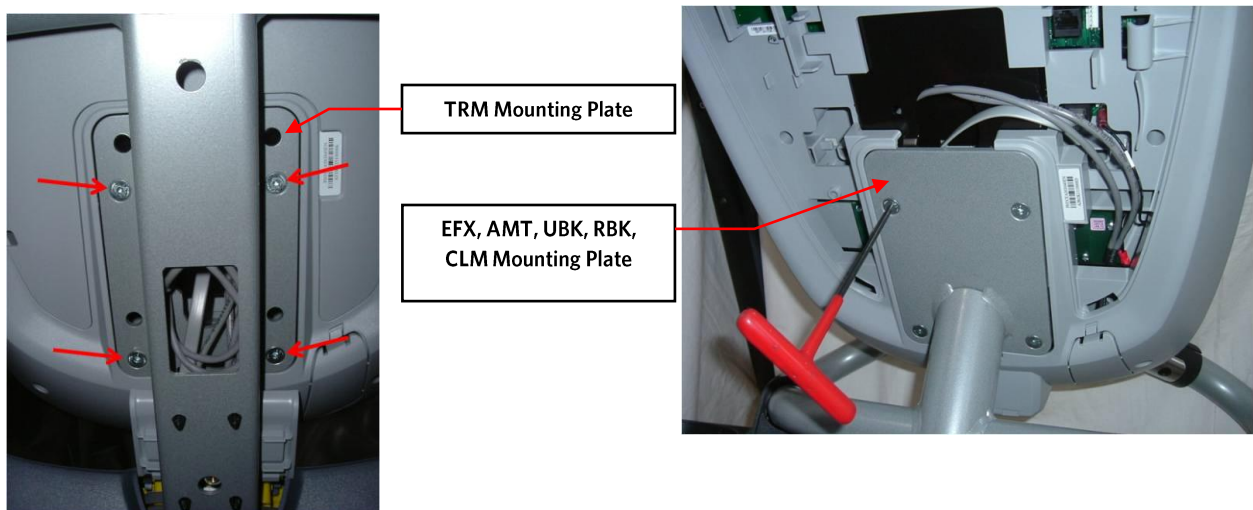

5. Remove the two screws that fasten the access panel to the console. **See Diagram 5.6.3**

Diagram 5.6.3 – Console Access Panel



6. Remove the back access panel:
 - a. Treadmills: Lift the console off the maintenance hook and then position the console so that the back panel is accessible and remove the back cover.
 - b. AMT's, EFX's, CLM's, UBK's, and RBK's: Tilt the console forward on the maintenance access hook on the dash weldment and remove the back. **See Diagram 5.6.4.**

Diagram 5.6.4 – Maintenance Access Hook

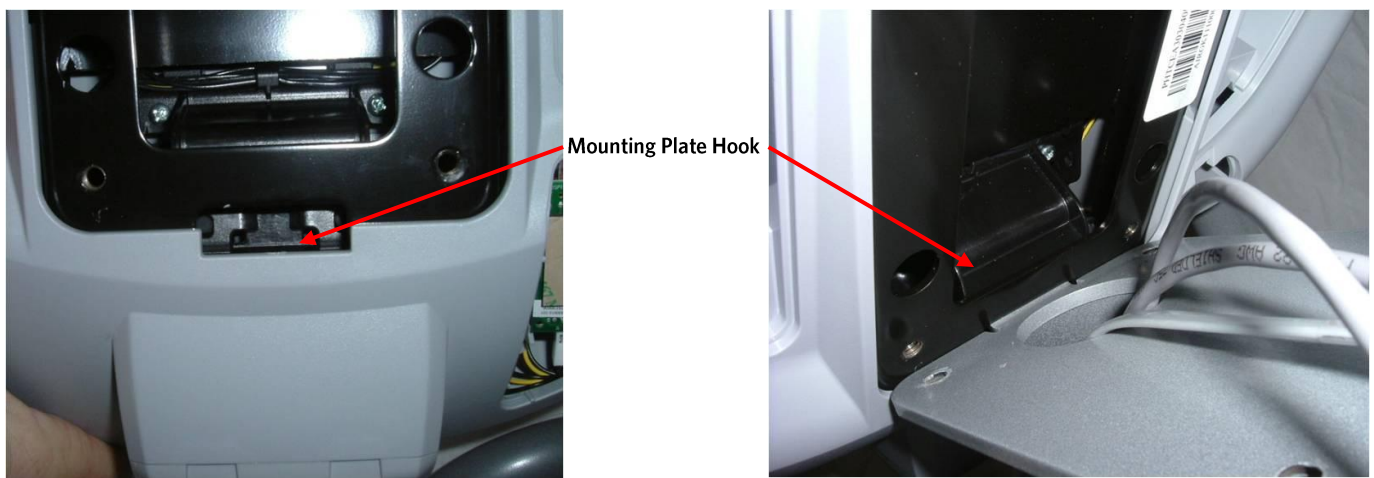

7. Remove the Heart Rate PCA. **See Procedure 5.7, Removing Heart Rate PCA.**
8. Disconnect the Heart Rate Cable from the Heart Rate PCA.

9. Disconnect the Data cable, Auto Stop cable (Treadmill only), Stop Key cable (Treadmill only), Heart Rate ground wire and the CSAFE cable (if in use) from the Upper PCA. **See Diagram 5.6.5.** Remove the console from the maintenance access hook and place it on a flat work surface.

Diagram 5.6.5 - P30 Cable Connectors

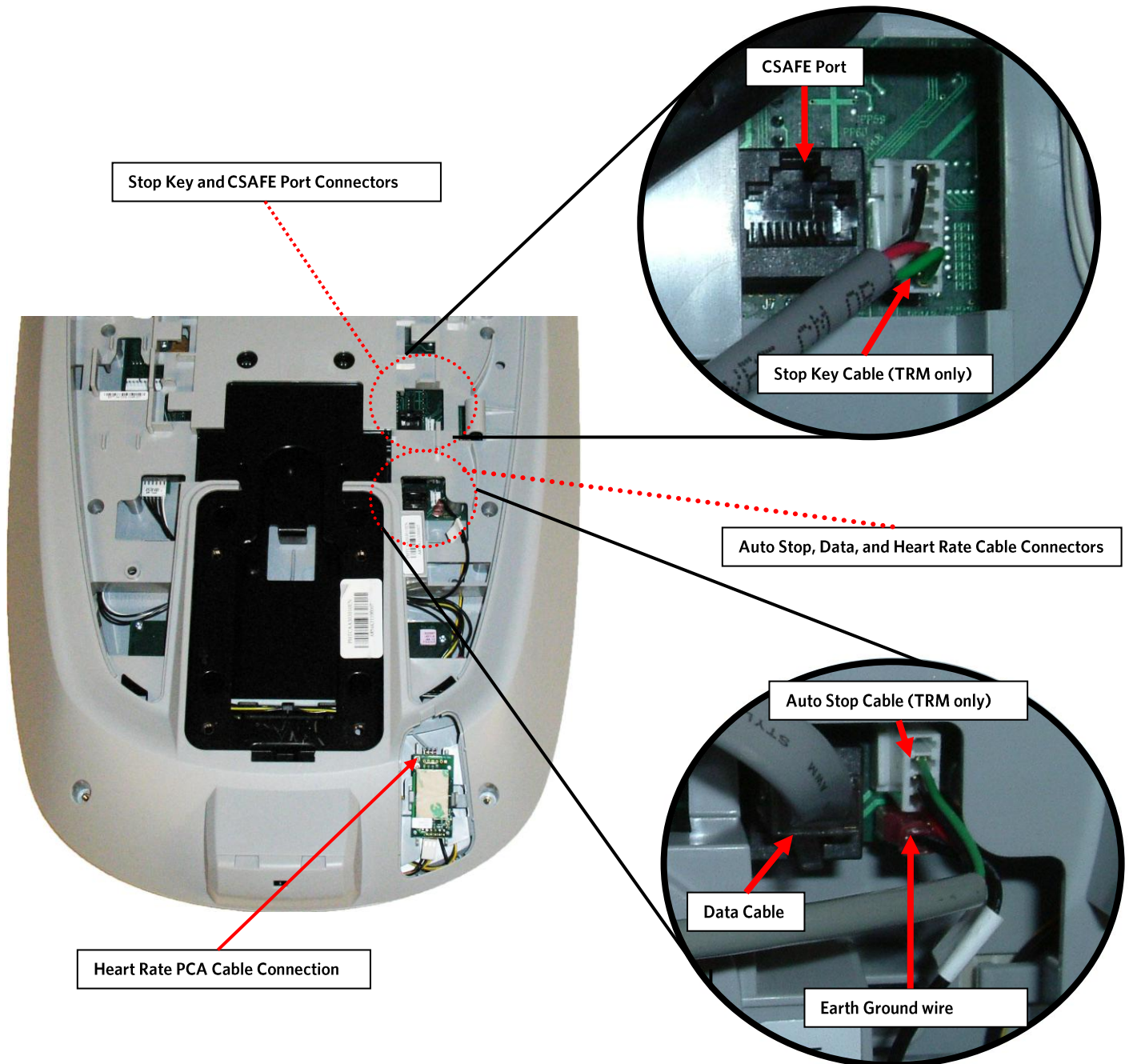

10. Remove the two screws that fasten the back cover to the option cap and remove the cover. **See Diagram 5.6.6**

Diagram 5.6.6 – Option Cap Back Cover



11. Remove the 6 screws that fasten the rear cover from the console and remove. **See Diagram 5.6.7.**

Diagram 5.6.7 – Rear Console Cover

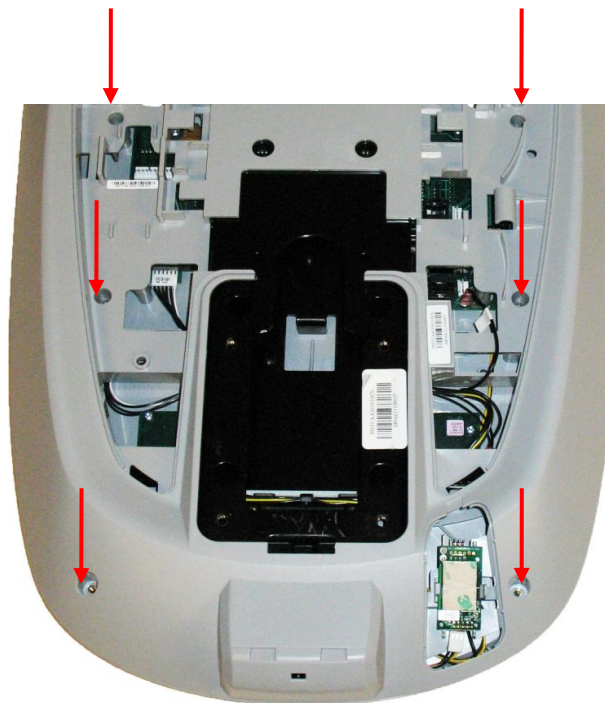

14. Replace the four spacers removed in step 13 onto the console mounting studs. The spacers must be used to insure the Metrics LED's are flush with the display window. If spacers are not used the Metrics LED's will apply excessive pressure on the Metrics board and may cause damage to the Metrics board.
15. Install the replacement Metric PCA into the console using the four screws removed in step 13.
16. The white wire in the Metrics cables indicate pin 1. Align the white wire in the Metrics cables with the pin 1 markings on the Metrics PCA. **See Diagram 5.6.9**

Note: If pin 1 is not marked on the Upper PCA refer to **Diagram 5.6.9**.

Diagram 5.6.9 – P30 PCA – Pin 1 Reference

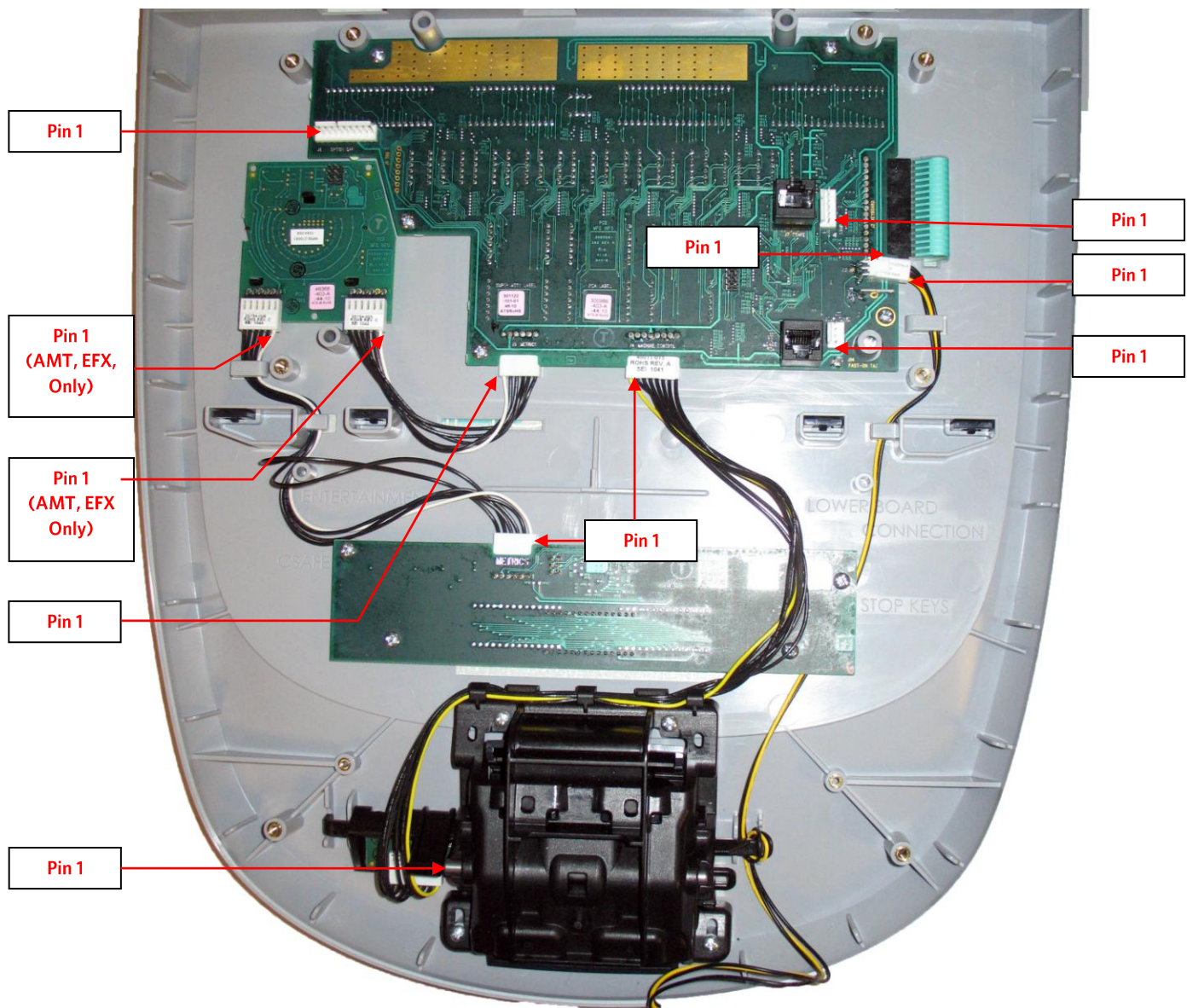

17. Connect the Metrics cable to the Metric PCA.
18. Replace the P30 Rear Cover removed step 11 and secure the cover with the screws 6 screws. Torque to 10 inch pounds.
Note: Do not use an electric screw driver or over tighten the screws. Over tightening may damage the console. This type of damage is not covered under warranty.
19. Replace the P30 Option Cap back cover removed step 12 and secure the cover with the screws 2 screws. Torque to 10 inch pounds.
Note: Do not use an electric screw driver or over tighten the screws. Over tightening may damage the console. This type of damage is not covered under warranty.
20. Place the P30 console on the maintenance access hook.
21. Reconnect the Data cable, Auto Stop cable (Treadmill only), Stop Key cable (Treadmill only), Heart Rate ground wire and the CSAFE cable (if in use) from the Upper PCA. **See Diagram 5.6.5.**
22. Reconnect the Heart Rate Cable to the Heart Rate PCA.
23. Replace the the Heart Rate PCA. **See Procedure 5.7, Removing Heart Rate PCA**
24. Replace the access cover with the hardware removed in step 6.
25. Tilt the console back against the mounting plated. While tilting the console back feed the excess cable into weldment tube making sure that the cables will not become pinched.
26. Fasten the console to the dash mounting plate with the four screws removed in step 4. **See Diagram 5.6.2.**
27. Fasten the dash transition cover using the two screws removed in step 3. **See Diagram 5.6.1**
Check treadmill operation per Section Seven.

Procedure 5.7 – P30 – Replacing Heart Rate PCA

1. Set the treadmill circuit breaker in the “off” position and unplug the treadmill’s line cord from the AC outlet (Treadmill only).
2. The PCA’s in the console are static sensitive. They can be damaged if proper static prevention equipment is not used. Attach an anti-static wrist strap to your arm, and then connect the ground lead of the wrist strap to frame ground.
3. Remove the HR PCA access panel on the back of the console. **See Diagram 5.7.1**
4. The HR PCA snaps into its mounting. Press its tabs downward and remove the HR PCA from its mounting.
5. Disconnect the HR cable and handlebar cable from the HR PCA. **See Diagram 5.7.2.**
6. Connect the HHR Grip cable assembly to the upper connector on the HR PCA and the HR PCA Power cable to the lower connector on the replacement HR PCA. **See Diagram 5.7.2.**
7. Orient the replacement HR PCA so that the side with the protective foam pad is facing out and snap the HR PCA into its mounting.
8. Replace the HR PCA access panel removed in step 3.
9. Check operation per Section 7

Diagram 5.7.1

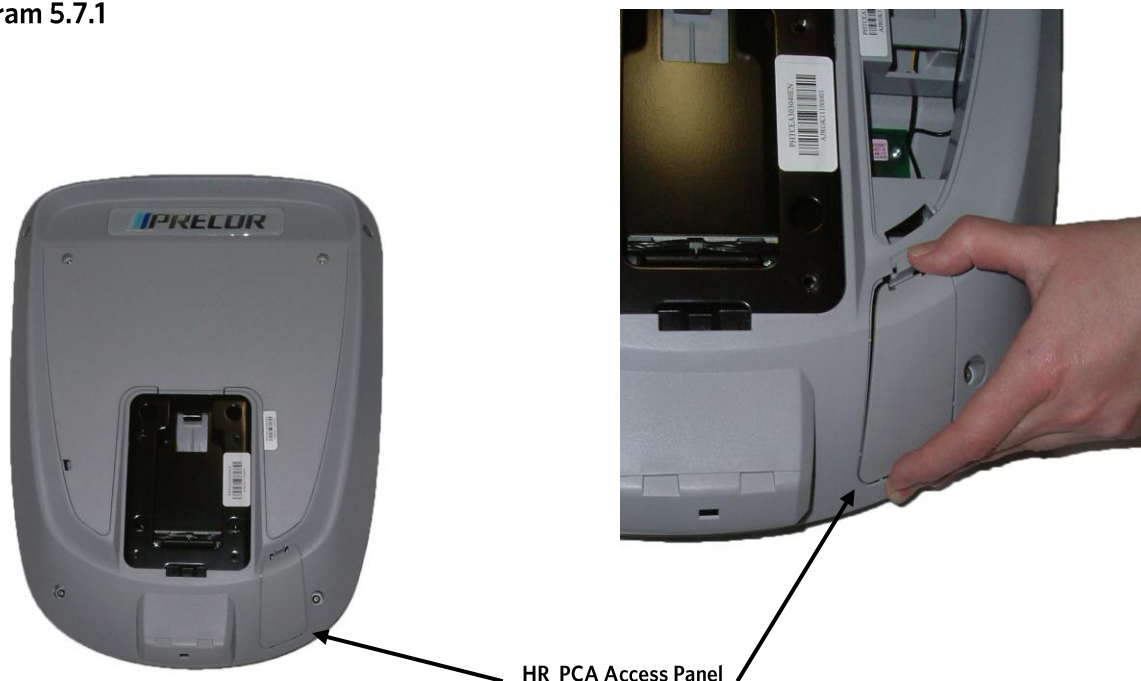
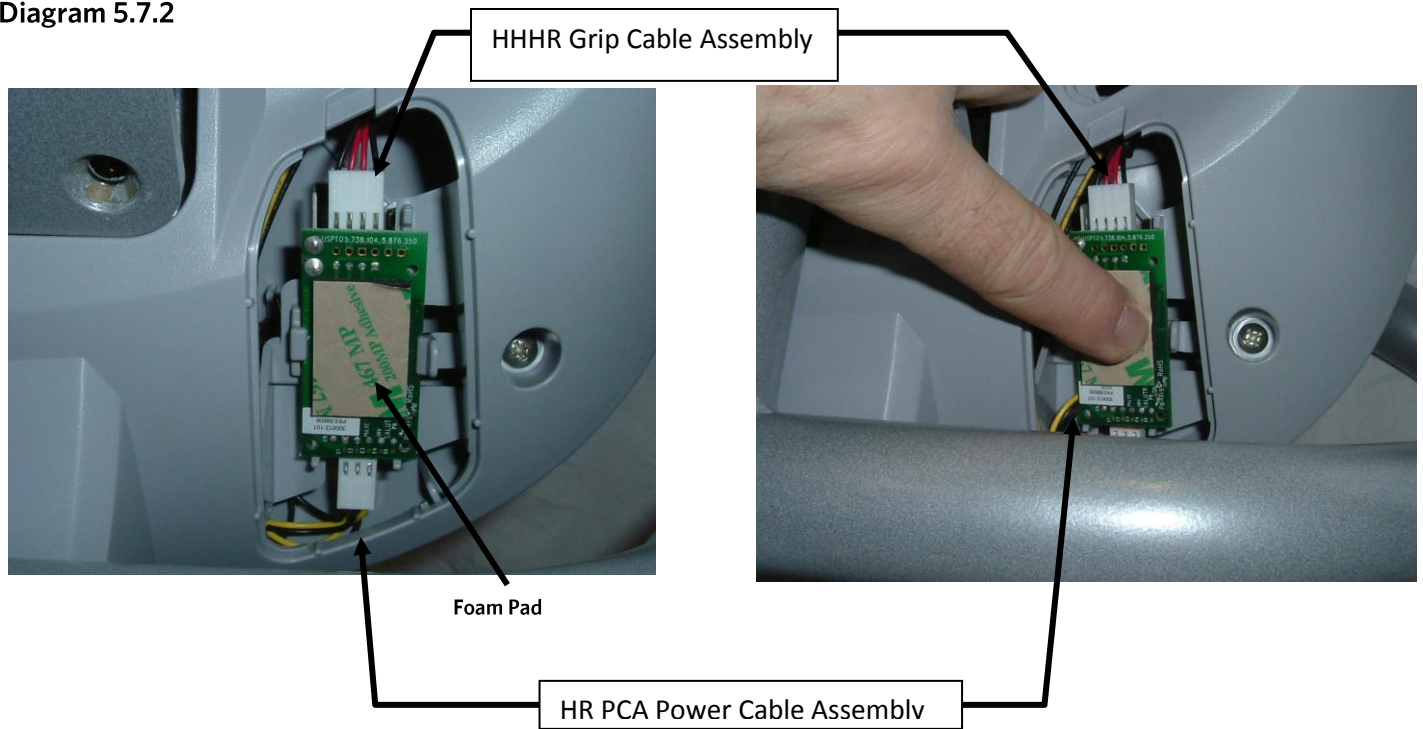

Diagram 5.7.2



Procedure 5.8 - Future Content

Procedure 5.9 – P30 – Flash Programming the Upper PCA

This unit utilizes an upper PCA software system that is capable of on site upper PCA software uploading (re-programming). The software upload may be accomplished with the use of a PDA (palm device) or a laptop computer.

If a palm device is to be used it must use OS software version 3.2 or higher. Currently, we have only tested devices manufactured by Palm, but other manufacturer's palm devices may also function correctly.

If a palm device is to be used, the appropriate software must be available in the palm device. A PDA containing the appropriate software may be ordered from Precor or it may be downloaded to the PDA from your desktop or laptop computer via the "hot sync" function. With the PDA inserted in the hot sync cradle, download to "Precor IFP" (in field programmer) directory.

If a laptop computer is to be used, the computer's DB9 serial port will be used for the upload.

Upload Procedure

1. The EFX must be "powered down" before the upload procedure can be initiated. Ensure that the EFX has not been used for a sufficient time to allow the lower PCA to completely discharge. The light emitting diode on the lower PCA will go out when the power supply is discharged.
2. If the CSAFE port is in use, temporarily disconnect the RJ-45 cable from the CSAFE port. If the CSAFE port is not in use, temporarily remove the plastic plug from the CSAFE port.
3. Connect the PDA or computer interface cable to the CSAFE port.
4. Select the software file to be uploaded on the palm device or computer.
5. Start pedaling the EFX or power up using the external power supply. When the EFX "powers up" the upload will commence. You must continue to pedal until the upload is complete, approximately 2 minutes.
6. Stop pedaling or disconnect the external power supply when the upload is complete, and allow the lower PCA to completely discharge. The light emitting diode on the lower PCA will go out when the power supply is discharged.
7. Start pedaling the EFX, after it has been allowed to power down, the EFX will now be operating on the newly uploaded software.
8. Thoroughly, check the EFX's function per Section Seven.

Procedure 5.10 – Future Content

Troubleshooting 5.11 – P30 – Troubleshooting the Keypad and the Upper PCA

Procedure

Note: The white or yellow wire on the cables shown in **Diagram 5.5.9** denotes pin 1. When these cables are inserted into their connectors, the white or yellow wire must align with the pin 1 designation on the PCA. If pin 1 is not marked on the PCA refer to **Diagram 5.5.9**.

1. Set the treadmill's on/off switch in the "off" position (Treadmill only). Access the upper electronics and machine controls per [Procedure 5.5, steps 1 through 12](#). Place the console on the maintenance mounting hook and reconnect all cables.
2. If the message STUCK KEY is displayed when the unit is turned on for treadmill's or pedaling on the RBK, UBK, AMT, and EFX, skip to step 23.
3. If a key does not function, skip to step 18.
4. If the display does not illuminate, continue with step 5.

Diagram 5.11.1 - Console, Upper PCA, JTAG (J9) Connector

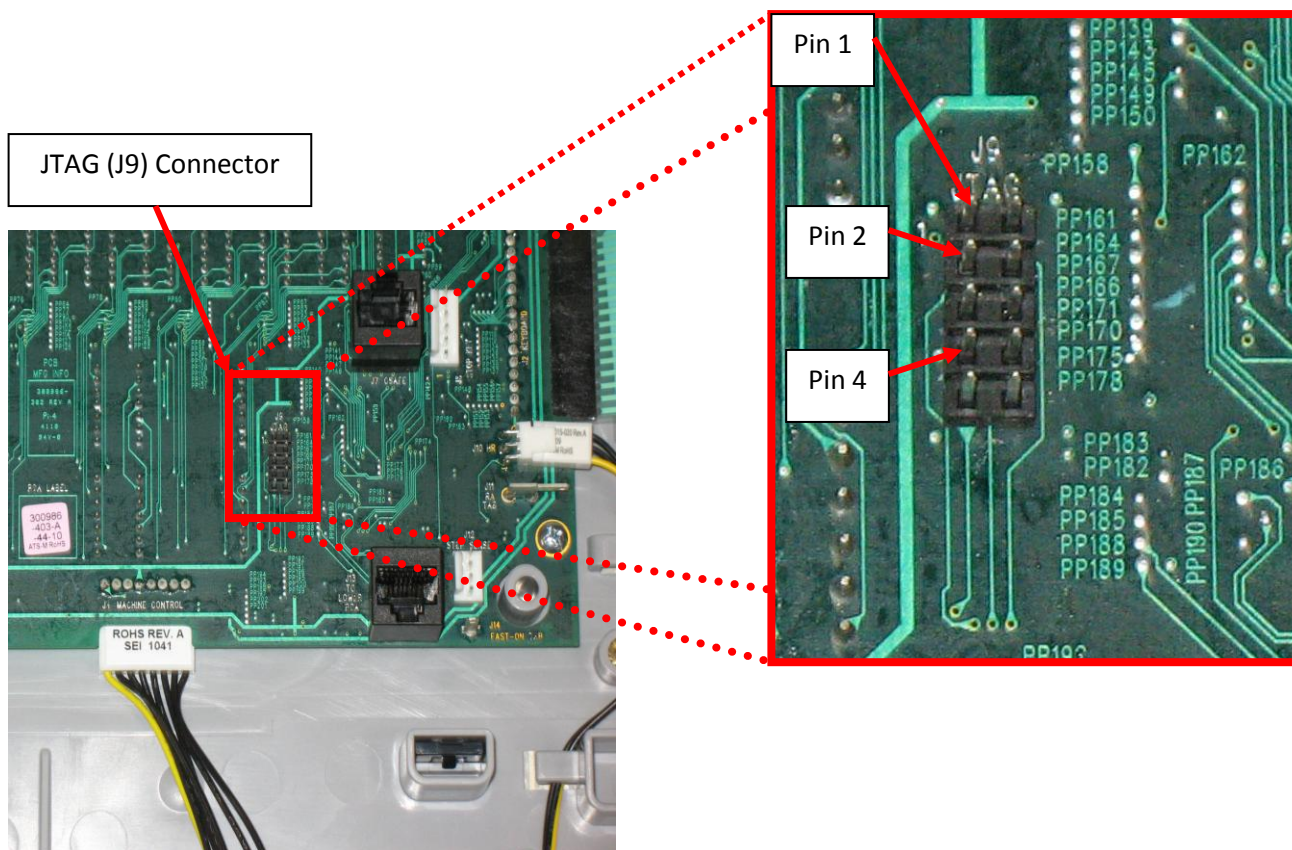
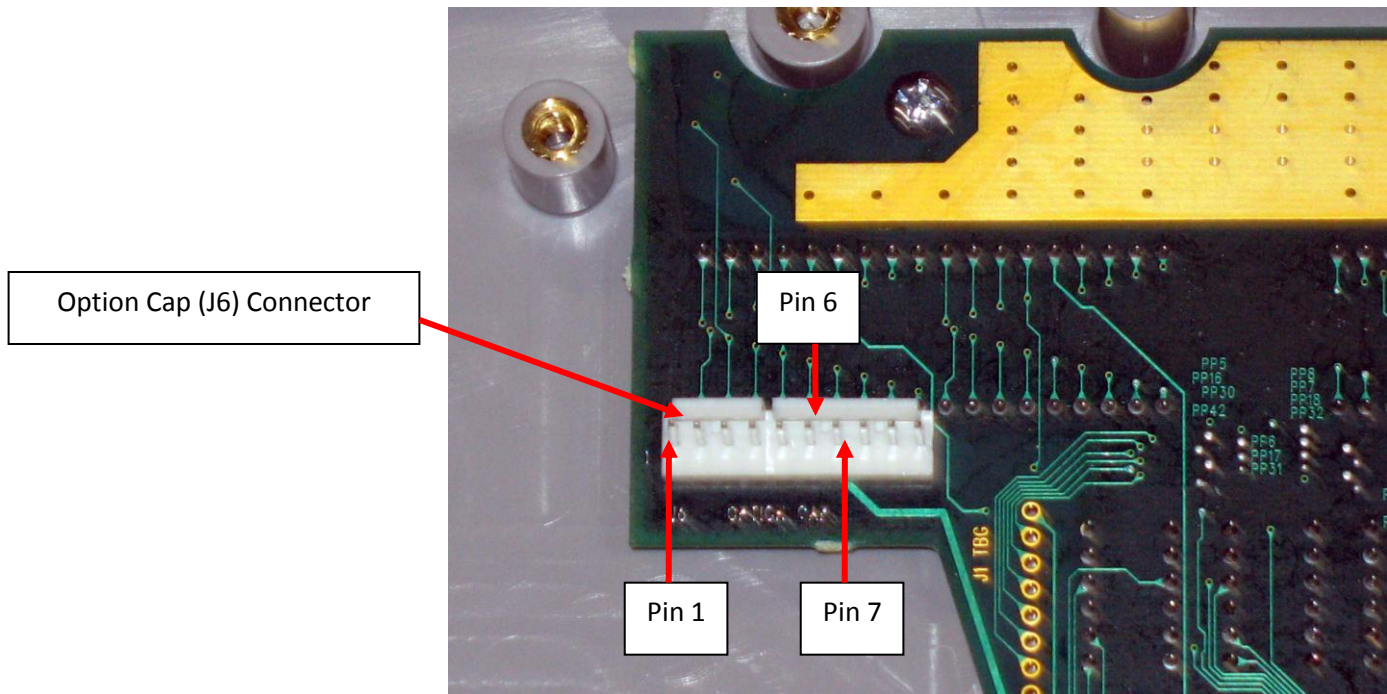
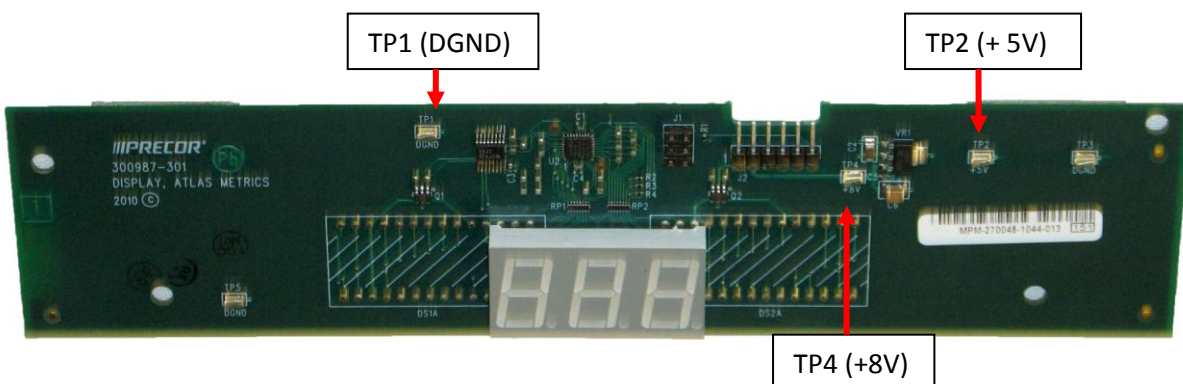

Diagram 5.11.2 - Console, Upper PCA , Option Cap (J6) Connector

5. If the upper PCA is not illuminating, skip to step 12.
6. If the metrics PCA is not illuminating, continue with step 7.
7. Remove the four screws that fasten the metrics PCA to the display face and rotate it so that the front of the PCA is visible. For treadmill's set the on/off switch in the "on" position for AMT's, EFX's, UBK's, RBK's and CLM's start pedaling.

Note: There are four spacers between the Metric board and the mounting studs. These must be saved and reinstall with the Metric board. If they are not used the Metric board or display face may become damaged.

8. With a DC voltmeter, measure between TP4 (+8V) and TP1 (DGND) for 8 Vdc and between TP2 (+5V) and TP1 (DGND) for 5Vdc. See Diagram 5.11.3

Diagram 5.11.3 - Metrics PCA, Front View

9. If 5 Vdc is not present on TP2 and 8 Vdc is present on TP4, replace the metrics PCA.
10. If 8 Vdc is not present on TP4 and the upper PCA is illuminating normally, replace the cable between the upper PCA and the metrics PCA.
11. If you have performed steps 7 - 10 and the metrics PCA still does not illuminate, contact Precor customer support for assistance.
12. For treadmill's set the on/off switch in the "on" position, for AMT's, EFX's, UBK's, RBK's and CLM's start pedaling.
13. With a DC voltmeter, measure between pins 2 and 4 of J9 (JTAG Connector) for 5 Vdc and between pins 6 and 7 of J6 (Option Cap) for 8 Vdc.
14. If 5 Vdc is not present on J9 and 8 Vdc is present on J6, replace the upper PCA.
15. If 8 Vdc is not present on J6, temporarily replace the upper PCA to power control module (treadmill's) or Lower PCA (AMT's, EFX's, UBK's, RBK's and CLM's), cable with a known good cable.
16. If the upper PCA illuminates normally, replace the upper PCA to power control module cable permanently. If the upper PCA still does not illuminate, replace the power control module (treadmills) or Lower PCA (AMT's, EFX's, UBK's, RBK's and CLM's).
17. If you have performed steps 12 - 16 and the upper PCA still does not illuminate, contact Precor customer support for assistance.
18. For treadmill's set the on/off switch in the "on" position for AMT's, EFX's, UBK's, RBK's and CLM's start pedaling.
19. If none of the keys on the display are functioning, check the stop switch cable connection to the upper PCA. (Treadmill Only). If the stop switch is not connected or the stop switch is not functioning, none of the display keys will operate. This feature insures that the treadmill has a functioning stop switch when it is in use (Treadmill Only).
20. If a particular key is not functioning, perform the keyboard test in **Procedure 5.2**. If the test verifies that the key is not functioning, replace the console face or the machine controls.
21. If the console face or the machine controls has been replaced and the same key or control is still not functioning, replace the upper PCA.
22. If you have performed steps 18 - 22 and the same key is still not functioning, contact Precor customer support for assistance.
23. Remove the keypad cable from the upper PCA. **See Diagram 5.5.8.**
24. For treadmill's set the on/off switch in the "on" position for AMT's, EFX's, UBK's, RBK's and CLM's start pedaling.
25. If the STUCK KEY message is no longer displayed, replace the console face.
26. Set the treadmill's on/off switch in the "off" position (Treadmills Only).

27. Remove the Machine Control cable from the upper PCA.
28. For treadmill's set the on/off switch in the "on" position for AMT's, EFX's, UBK's, RBK's and CLM's start pedaling.
29. If the **STUCK KEY** message is no longer displayed, replace the machine Controls assembly.
30. If the **STUCK KEY** is still being displayed with the keyboard cable disconnected, replace the upper PCA.
31. If you have performed steps 23 - 30 and the **STUCK KEY** message is still being displayed, contact Precor customer support for assistance.

Troubleshooting 5.12 - P30 - Troubleshooting Handheld Heart Rate

Circuit Description

The hand held heart rate system is actually a dual system, that is, it can accept a heart rate signal from either the hand held heart rate contacts on the unit's handlebar or from a Polar heart rate chest strap transmitter. The PCA is configured for hand held priority. That is, if both a chest strap and hand heart rate signal are being received, the system will accept the hand held signal and ignore the chest strap signal. If a hand held signal is not being received, the system will accept the chest strap signal.

Note:

There are four typical failure modes for the hand held/chest strap heart rate system. They are: hand held is normal - no chest strap reading; no hand held reading - chest strap normal; no hand held or chest strap reading or constant or intermittent readings when neither hand held or chest strap are in use.

Diagram 5.12.1 - Hand held/chest strap heart rate PCA

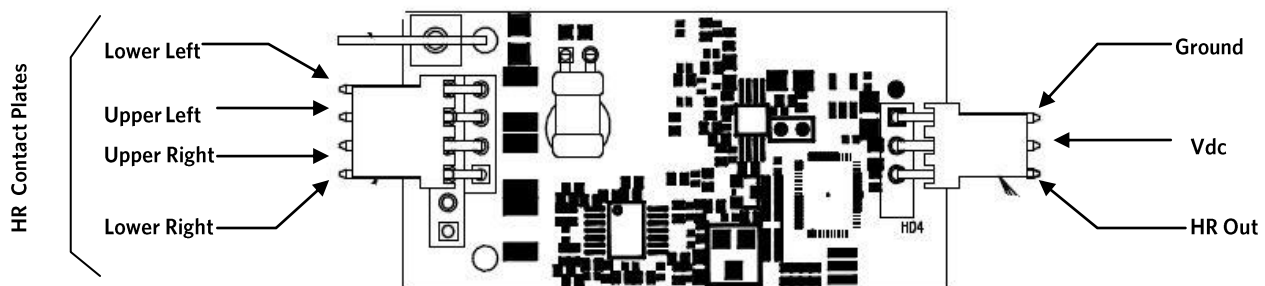

Normal hand held reading - No chest strap reading

1. Access the diagnostic program (Procedure 5.1). Advance to the heart rate display portion of the diagnostic program. Verify that a chest strap signal is not being accepted with either a Polar heart rate test transmitter or a known good chest strap transmitter. If this reading is good, skip to step 3.
2. Using a known good Polar heart rate chest strap, verify that the heart rate operates with the known good chest strap. If the known good Polar chest strap does correct the problem, replace the original chest strap transmitter.
3. If the above procedures did not correct the problem, replace the heart rate PCA.

No hand held reading - Normal chest strap reading

4. Access the diagnostic program (Procedure 5.1). Advance to the heart rate display portion of the diagnostic program. Verify that a hand held signal is not being accepted by firmly grasping both the right and left hand held contacts on the handlebars. Cover as much of the top and bottom contact surface area with your hands as possible (without moving your hands), you should receive a heart rate reading within ten seconds.
5. If the hand held signal is now being accepted, something in the near vicinity is radiating RF (radio frequency) energy that is being received by the chest strap portion of the heart rate PCA.
6. If a hand held signal still not being accepted, skip to step 8.
7. Replace the heart rate PCA with a 300812-101 (or higher) heart rate PCA. 300812-101 and higher versions of heart rate PCA are less susceptible to radiated RF energy.
8. Access the diagnostic program (Procedure 5.1). Advance to the heart rate display portion of the diagnostic program. Verify that a hand held signal is not being accepted by firmly grasping both the right and left hand held contacts with the opposite hands, right hand on the left handlebar contacts and left hand on the right handlebar contacts. Cover as much of the top and bottom contact surface area with your hands as possible, you should receive a heart rate reading within ten seconds. If a hand held signal is still not being accepted, skip to step 10.
9. If a hand held signal was accepted in step 8, the hand held contact wiring is reversed. The harness that connects to the hand held contacts in the handlebar is segregated into two groups. One group has blue shrink wrap around it and the other group has black shrink wrap around it. The "blue" group must go to the right hand contacts and the "black" group must go to the left hand contacts. If necessary, rewire the hand held contacts as described above and test as described in step 4.
10. If the wiring is correct, refer to Diagram 5.12.1 for the following measurements. With an ohmmeter measure between the "lower right contact" pin on the J1 connector and the lower right hand held heart rate contact on the handlebar. The reading should be $1\ \Omega$ or less. Measure between the "upper right contact" pin on the J1 connector and the upper right hand held heart rate contact on the handlebar. The reading should be $1\ \Omega$ or less. Measure between the "upper left contact" pin on the J1 connector and the upper left hand held heart rate contact on the handlebar. The reading should be $1\ \Omega$ or less. Measure between the "lower left contact" pin on the J1 connector and the lower left hand held heart rate contact on the handlebar. The reading should be $1\ \Omega$ or less. If any of the above readings are greater than $1\ \Omega$, replace the heart rate PCA to handlebar wire harness.

No hand held reading - No chest strap reading

11. Access the diagnostic program (Procedure 5.1). Advance to the heart rate display portion of the diagnostic program. Verify that neither a chest strap signal or a hand held signal is being accepted with either a heart rate test transmitter or a chest strap transmitter.
12. Check the plug/connector connections on both the heart rate PCA (J4), and upper PCA (J1).
13. If neither a chest strap signal or a hand held signal is being accepted, measure between the "ground" and "5 Vdc" pins on J4 for 5 Vdc. If 5 Vdc is present, replace the heart rate PCA.
14. If 5 Vdc is not present, remove the connector from J4 of the heart rate PCA. Measure between the "ground" and "5 Vdc" pins of the connector (just removed from the heart rate PCA) for 5 Vdc. If 5 Vdc is present, replace the heart rate PCA. If the 5 Vdc is not present, measure between the corresponding pins of J1 on the upper PCA (red and black wires). If 5 Vdc is not present replace the upper PCA. If 5 Vdc is present, replace the upper PCA to heart rate PCA cable.

Constant or intermittent readings when neither the hand held or chest strap is in use.

Verify that a ferrite core is clamped around the heart rate PCA to upper PCA cable. Constant or intermittent heart rate readings when neither heart rate system is in use is caused by something in the near vicinity radiating RF energy that is being received by the chest strap portion of the heart rate PCA. Replace the heart rate PCA with a 300812-101 (or higher) heart rate PCA. 300812-101 and higher versions of heart rate PCA are less susceptible to radiated RF energy.

Troubleshooting 5.13 – Upper Display does not Illuminate

1. Because this is self powered unit, the display will not illuminate until it is used or the optional external power supply is equipped. If the optional external power supply is equipped, the display should be constantly illuminated. If the optional external power supply is not equipped, the unit must be used at a stride rate of 20 strides per minute or higher for the display to illuminate.
2. If the optional external power supply is not equipped, skip to step 5.
3. Disconnect the optional external power supply from the EFX and measure between the inner and outer sleeves of the power supply's output jack with a DC voltmeter. You should measure approximately 18 VDC.
4. If the voltage measured in step 3 was significantly low, replace the optional external power supply. If the voltage measured in step 3 was 0 Vdc, disconnect external power supply from its AC outlet and measure the voltage at the AC outlet. If the AC outlet voltage is normal replace the optional external power supply. If the AC outlet voltage is significantly low or 0 Vdc, the AC system must be inspected by an electrician.
5. Troubleshoot the generator per Procedure 9.2.
6. If the generator was found to be good, the problem will be in either the lower PCA, upper PCA or the upper to lower PCA interconnect cables.

Warning

Because this is a self powered unit, it will either be necessary to either equip the unit with the optional external power supply or have an assistant pedal on the unit while voltage measurements are being taken. Because of the danger of working on the unit while it is in motion using the optional external power supply is strongly recommended.

7. Remove the rear cover and disconnect the interconnect cable from the J2 connector of the lower PCA.
8. The following voltage reading must be taken while the unit is in motion. Extreme care must be taken to keep meter leads, hands, etc. clear of all moving parts. Using a DC voltmeter, measure the voltage between TP13 (+5D) and TP4 (DGND). Refer to Diagram 5.13.1. The voltage measured should be approximately 5 Vdc. If the voltage is significantly low, replace the lower PCA. Additionally, the DS1 LED should illuminate.
9. Reconnect the interconnect cable to the J2 connector of the lower PCA and repeat the voltage measurement in step 8. The voltage measured should be approximately 5 Vdc. If the voltage is significantly low, the problem is in the upper PCA or the upper to lower PCA interconnect cables.

Diagram 5.13.1 - Partial View of Lower PCA

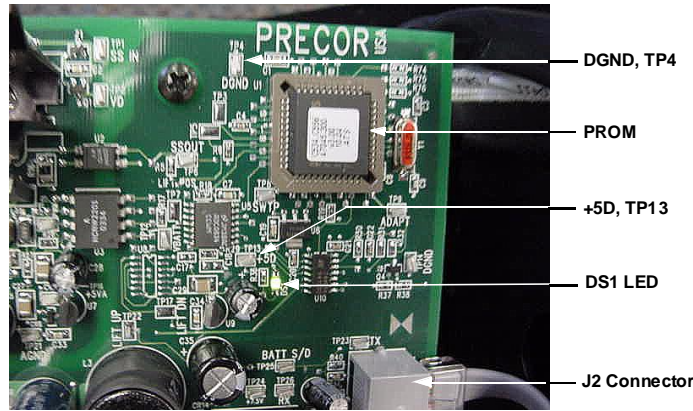

10. Troubleshoot the upper to lower PCA interconnect cables per Procedure 9.1.
11. If the upper to lower interconnect cables are found to be good, replace the upper PCA.
12. If you have performed all of the above tests and are unable to resolve the problem, contact Precor customer support.

Section Six - Future Content

Section Seven – Checking EFX Operation

This section provides you with a quick method of checking EFX operation. Check the operation of the EFX at the end of most maintenance procedures.

Procedure

1. Start striding on the C546i or plug the optional external power supply (when available) into the EFX and the AC outlet.
2. When the **PRECOR** banner displayed, press **GO** (P80) or **QUICK START (P30)**.
3. Select Resistance Level 1.
4. Operate the EFX for 4-5 minutes. As you operate the EFX, concentrate on the operating sounds made by the unit. Be on the alert for unusual rubbing, hitting, grinding, or squeaking noises.
5. If the EFX makes unusual noises, troubleshooting per Section Nine.
6. If the EFX electronic display does not change appropriately, troubleshoot per Section Three (P80) or Five (P30), Troubleshooting the Keypad and Upper PCA.
7. Press the **RESISTANCE ▲** key until you reach Resistance Level 10. Operate the EFX for another 2-3 minutes.
8. If the EFX resistance does not change or the operation of the EFX feels inconsistent compared with Resistance Level 1, troubleshoot per Section Nine.
9. Press the **RESISTANCE ▲** key until you reach Resistance Level 20. Operate the EFX for another 2-3 minutes.
10. If the resistance of the C546i does not change or the EFX operation feels inconsistent with Resistance Levels 1 and 10, troubleshoot per Procedure 9.2.
11. Check the LED's mounted on the upper PCA and the function keys displayed on the electronic console by performing, console diagnostics tests, Section Three (P80) or Five (P30).
12. Press the **CROSSRAMP ▲ key** while viewing the electronic console. Confirm that the foot pads incline and the ramp display increments to 20 as the **CROSSRAMP** key is pressed.
13. Press the **CROSSRAMP ▲ key** while viewing the electronic console. Confirm that the foot pads return to a level position and the ramp display decrements to 1 as the **CROSSRAMP** key is pressed.
14. If the incline system of the EFX does not operate properly, troubleshoot per Procedure 9.3.

Section Eight - Inspection and Adjustment Procedures

Procedure 8.1 - Measuring the Resistance of a Generator

Caution

If an external power supply is connected to the EFX, disconnect the external power supply from the EFX before continuing with this procedure.

Procedure

Remove the screw at the right rear of the rear cover. Grasp the right side of the rear cover and rotate it counterclockwise to remove the cover. Refer to Procedure 10.1.

Remove the two screws that retain the black plastic shield. Remove the black plastic shield from the EFX.

Remove the red battery lead from the lower PCA. See Diagram 10.3.1

WARNING

Before continuing with this procedure, review the Warning and Caution statements listed in Section One, Things You Should Know.

1. Set the ohmmeter to a range that will conveniently read up to 50 W.
2. Remove the six phase generator connector from the lower PCA, refer to **Diagram 8.1.1**, below.
3. With an ohmmeter, read between terminals 1 & 2, terminals 1 & 3, terminals 1 & 5, terminals 1 & 6, and terminals 1 & 7 on the six phase generator connector (J1). Each of the readings should be between 36 W and 40 W.
4. If any of the readings are significantly high or significantly low, remove the intermediate cable from the generator and perform the same measurements as in step 4 on the generator connector. If the reading is now correct check and or replace the intermediate cable. Refer to **Diagram 8.1.1**. If the readings are still incorrect, remove the six phase generator.
5. Replace the generator per Procedure 10.17. Reconnect the intermediate cable removed in step 5 to the replacement generator and the lower PCA.
6. Reconnect the red battery lead to terminal M6 of the lower PCA.
7. set the black plastic shield in its mounting position and fasten it with the screws removed in step 2.
8. Set the right side of the rear cover in it's mounting position and rotate it clockwise. Ensure that the cover is fully engaged and fasten it with the screw removed in step 1.

Diagram 8.1.1

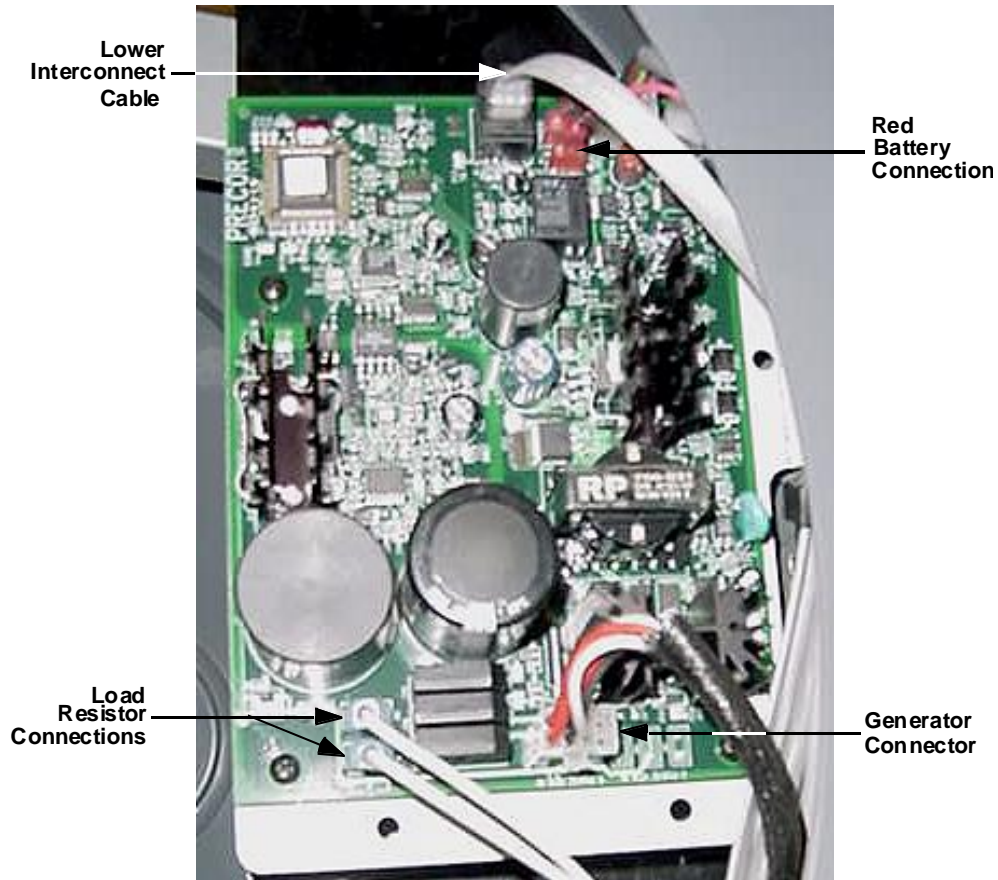

Procedure 8.2 – Inspecting and Adjusting Belt Tension

Procedure

1. Remove both screws at the rear of the rear cover. Grasp the right side of the rear cover and rotate it counterclockwise to remove the cover. Grasp the left side of the rear cover and rotate it clockwise to remove the cover. Refer to procedure 7.1.

WARNING

Before continuing with this procedure, review the Warning and Caution statements listed in Section One, Things You Should Know.

WARNING

If the EFX has been in recent use, the load resistors and mounting bracket may be extremely hot.

2. Remove the two screws that retain the black plastic shield on the left side of the EFX. Remove the black plastic shield from the EFX.
3. Place a 20030-108 or equivalent belt gauge on the input belt as shown in Diagram 8.2.1.

Diagram 8.2.1 - Input Belt Tension Measurement

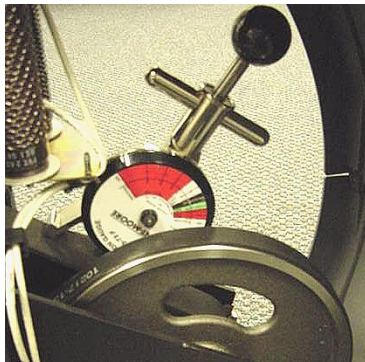

Left Side Adjustment Bolt

4. The belt gauge should read approximately 160 lbs. If the belt tension is significantly high or low the belt tension may be adjusted using the adjustment bolts shown in Diagram 8.2.1. To adjust the belt tension, first straighten the locking tabs on both bolts. When adjusting the tension, turn both bolts equal amounts. When the adjustment is complete the step up pulley shaft must remain perpendicular to the frame and drive belt. Turning the adjustment bolts clockwise will increase belt tension, turning the adjustment bolts counter-clockwise will decrease belt tension.

5. Changing the tension of the input drive belt will also affect the tension of the generator belt. If the input belt tension has been changed, continue with step 7.
6. Place a 20030-108 or equivalent belt gauge on the generator belt as shown in Diagram 8.2.2.

Diagram 8.2.2 - Generator Belt Tension Measurement

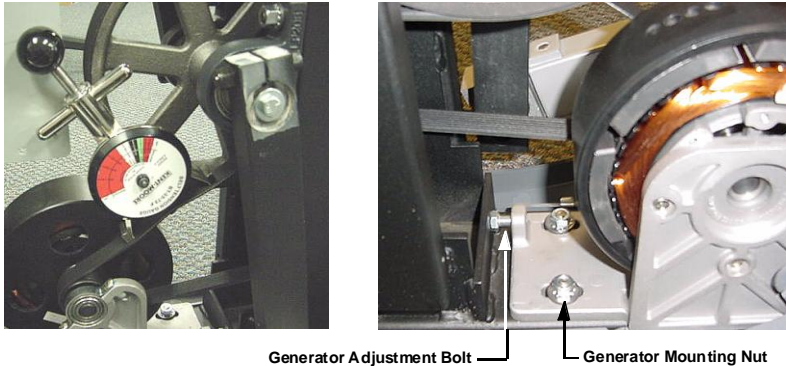

7. The belt gauge should approximately 110 lbs. If the generator belt tension is significantly high or low, it may be adjusted using the adjustment bolt shown in Diagram 8.2.2. First loosen, but do not remove the four generator mounting nuts. Thread the adjustment bolt into or out of the generator to change the belt tension. When the tension is correct, tighten the locking nut. Tighten and torque the four generator mounting nuts to 200 inch pounds.
8. If either the input pulley belt or the generator belt is being replaced with a new belt, the belt tension should be set 20 lbs. higher than the previous readings. Therefore a new input pulley belt should be tensioned to 180 lbs. and a new generator belt should be tensioned to 130 lbs. Over time and use the belts will "relax" and the tensions will be as stated in steps 4 and 7.
9. Reconnect the red battery lead to terminal M6 of the lower PCA.
10. Set the right side of the rear cover in its mounting position and rotate it clockwise. Ensure that the cover is fully engaged and fasten it with the screw removed in step 1. Set the left side of the rear cover in it's mounting position and rotate it counterclockwise. Ensure that the cover is fully engaged and fasten it with the screw removed in step 1

Procedure 8.3 - Calibrating the Incline Motor

1. Set the incline at its lowest position and remove the lift cover per Procedure 10.2.
2. Remove the four screws that retain the lower front portion of the front cover. Remove the lower front cover.
3. Grasp the center ramp cover and lift it to unsnap it from the ramp. Remove the cover.
4. Remove the two bolts that retain the incline motor yoke assembly in the ramp.
5. Carefully, slide the incline motor yoke out of the ramp and lower the ramp until it is resting on the frame.

Diagram 8.3.1 - incline Motor Mounting and Calibration

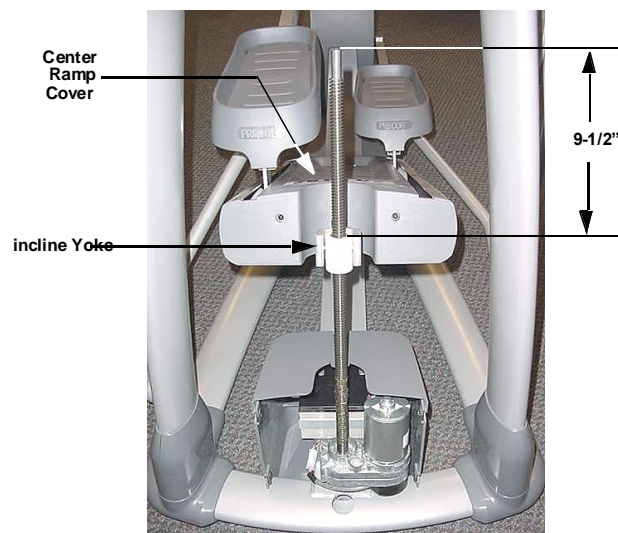

6. Access the incline A/D reading via the Lift Test portion of the Diagnostic Program, see Procedure 3.1 (P80) or 5.1 (P30).
7. With the A/D number displayed set it for a reading of 127 using the **CROSSRAMP q** and **CROSSRAMP p** keys.
8. Rotate the incline motor yoke on the incline motor drive screw until the measurement between the top of the incline nut and the end of the incline motor drive screw is 9-1/2 inches. See Diagram 8.3.1. While rotating the incline motor yoke, do not allow the incline motor drive screw to rotate. If the incline motor drive screw rotates, the A/D number will change. The A/D number must be 127 and the physical measurement must be 9-1/2 inches for the calibration to be correct.
9. Lift the ramp off of the frame and slide the incline motor yoke into the ramp. Do not rotate the incline motor yoke any more than is absolutely necessary to align the incline motor yoke with the ramp.
10. Fasten the incline motor yoke in the ramp with the hardware removed in step 3.

11. Replace the lower front portion of the front cover with the hardware removed in step 1.
12. Replace the lift cover per Procedure 10.2.
13. Operate the incline through its entire range to ensure proper operation.

Section Nine - EFX Troubleshooting Procedure

Troubleshooting 9.1 – Troubleshooting the Lower and Upper Interconnect Cables

1. Remove the five screws from the rear of the upper display housing. Remove the display housing front panel from the display housing. Disconnect the upper interconnect cable from the upper PCA.
2. Remove the four screws from the access cover below the display. Disconnect the upper interconnect cable from the mid-point connector. Refer to Diagram 9.1.1

Diagram 9.1.1 - Data Cable Mid-Point Connector

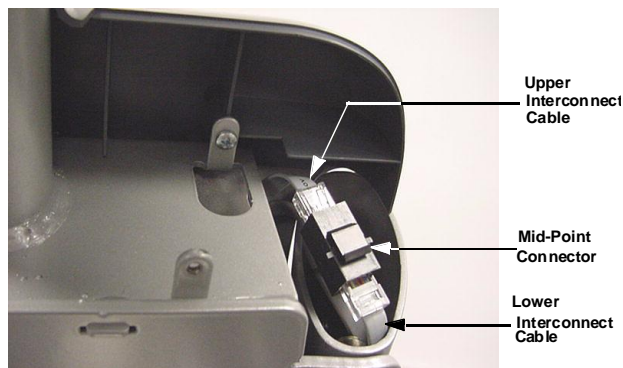

3. External of the upper column, connect a replacement upper interconnect cable to the mid-point connector and the upper PCA.
4. Check operation as described in Section Seven. If the unit works properly, replace the upper interconnect cable as described in Procedure 10.4.
5. If the symptoms are unchanged, remove the external upper interconnect cable. Reconnect the internal upper interconnect cable to the mid-point connector and the upper PCA. Set the display housing front panel in its mounting position and fasten it with the five mounting screws removed in step 1. Troubleshoot the lower interconnect cable starting with step 6.
6. Remove the right side rear cover as described in procedure 10.1.
7. Disconnect the lower interconnect cable from the mid-point connector and the lower PCA. Refer to Diagram 9.1.1.
8. External of the frame, connect a replacement lower interconnect cable to the mid-point connector and the lower PCA.
9. Check operation as described in Section Seven. If the unit works properly, replace the lower interconnect cable as described in Procedure 10.4.

10. If the symptoms are unchanged, remove the external lower interconnect cable. Reconnect the internal lower interconnect cable to the mid-point connector and the lower PCA. Remove the upper and lower interconnect cables from the mid-point connector. Connect a replacement mid-point connector between the two interconnect cables and retest the unit per Procedure 10.4.
11. If you have performed all of the procedures above and have been unable to correct the problem, call Precor customer support.

Troubleshooting 9.2 – Troubleshooting the Generator

The generator performs three functions in the EFX. First, by controlling the amount of electrical load applied to the generator, the user's pedaling resistance is controlled. Second, the generator is used to charge the EFX's internal battery. Lastly, one of the generator's six phase output windings is monitored to determine when the unit is in use and when it is idle. This system also determines the stride rate by determining the operating speed (output frequency) of the monitored generator winding.

Warning

Because this is a self powered unit, it will either be necessary to either equip the unit with the optional external power supply or have an assistant pedal on the unit while voltage measurements are being taken. Because of the danger of working on the unit while it is in motion using the optional external power supply is strongly recommended.

1. Perform the generator resistance test per Procedure 8.1. If any of the resistance measurements are significantly high or significantly low, replace the generator.
2. The following voltage reading must be taken while the unit is in motion. Extreme care must be taken to keep meter leads, hands, etc. clear of all moving parts. Using an AC voltmeter, measure the voltage between 1 & 3, 2 & 3, 5 & 7 and 6 & 7 on J1 of the lower PCA. All AC voltage readings will vary depending on the unit's stride rate at the time the measurement is taken. At a stride rate of 100 strides per minute, all three voltage readings will be approximately 100 VAC -110 VAC.
3. If any of the six readings in step 2 are significantly low, replace the generator.
4. If you have performed all of the above tests and are unable to resolve the problem, contact Precor customer support.

Troubleshooting 9.3 – Troubleshooting the Incline System

The incline motor is a 12 Vdc motor with an internally driven 1 KW potentiometer used to track ramp position. Because the incline motor is a DC motor, incline motor direction is controlled by the polarity of the DC voltage applied to the incline motor. When a positive voltage is applied to the incline motor, the incline motor will move upward. When a negative voltage is applied to the incline motor, the incline motor will move downward. As the incline motor moves the 1 KW potentiometer is rotated via an internal gear drive system. The potentiometer's changing resistance is fed to the incline control system and converted to an A/D (analog to digital) reading that is used in the diagnostics system to indicate ramp position.

The ramp operating system has a battery monitoring system. If the battery voltage falls below 11 Vdc when ramp movement is initiated or the battery voltage falls below 10 Vdc after ramp movement has been initiated, ramp movement will be stopped and the message "NO RAMP LOW VOLTAGE" will be displayed. Ramp motion will not be enabled until such time as the battery voltage exceeds the above limits. The battery voltage must be raised to correct this condition either by battery charging or battery replacement. This is strictly a battery problem and not an incline system or incline motor problem.

1. If an Error 40 (no incline movement) is being displayed continue with step 2. If an Error 42 is being displayed (incline out of range) skip to step 12.
2. If the incline moves briefly and then displays an Error 40, skip to step 12. If the incline does not move prior to displaying the Error 40 continue with step 3.
3. Remove the rear cover. Remove the F1 fuse (6.3 amps) from the lower PCA. See Diagram 6.4. Check the fuse's resistance using an ohmmeter. The fuse should read 1 W or less. If the reading is significantly high, replace the fuse. If the fuse is good or replacing the fuse does not correct the problem, continue with step 4.
4. Enter the diagnostic program per Procedure 3.1 (P80) or 5.1 (P30). Using the diagnostic program allows you to test the incline system without continuously pedalling the unit. Connect a DC volt meter to the J3 connector on the lower PCA as follows: voltmeter common lead to terminal 3 (black wire) and voltmeter "hot" lead to terminal 2 (red wire). Using the **CROSSRAMP** ▼,▲ keys operate the incline. The voltmeter should read +12 Vdc when the incline is instructed to move upward and -12 Vdc when the incline is instructed to move downward.
5. If when the **CROSSRAMP** keys are pressed, the display does not indicate that the incline should be moving, troubleshoot the upper PCA and keypad per Procedure 3.11 (P80) or 5.11 (P30).
6. If the voltage measurements in step 4 are correct continue with step 7. If either voltage measurement in step 4 is significantly low, replace the lower PCA.
7. Verify that all of the wires in the intermediate cable (the cable inserted into J3 of the lower PCA) are securely inserted into the connector housing and providing a good electrical connection.

8. Remove the lift cover per Procedure 10.2. Enter the diagnostic program, if necessary, per Procedure 3.1 (P80) or 5.1 (P30). Using the diagnostic program allows to test the incline system without continuously pedaling the unit. Connect a DC volt meter to the incline motor cable as follows: voltmeter common lead to terminal 2 (brown wire) and voltmeter "hot" lead to terminal 3 (red wire). Using the **CROSSRAMP ▲▼** keys operate the incline. The voltmeter should read +12 Vdc when the incline is instructed to move upward and -12 Vdc when the incline is instructed to move downward.
9. If the voltage measurements in step 8 are correct replace the incline motor. If the either voltage measurement in step 4 is significantly low, continue with step 10.
10. Verify that all of the wires in the intermediate cable (the cable inserted in to J3 of the lower PCA) are securely inserted into the connector housing and providing a good electrical connection.
11. If you have performed all of the above tests and are unable to resolve the problem, contact Precor customer support
12. Enter the diagnostic program per Procedure 3.2 and advance to the **Lift Test**. If the A/D reading is either 0 or 255, skip to step 15.
13. Using the **CROSSRAMP ▼▲** keys operate the incline. If the A/D reading tracks the incline movement smoothly without skips, calibrate the incline motor per Procedure 5.3 and re-test incline functions in a normal operating mode.
14. If the A/D reading was erratic and did not smoothly follow incline motion, visually check the connections between the intermediate cable and the J3 connector on the lower PCA and between the intermediate cable.
15. Exit the diagnostics program, and leave the unit idle long enough for it to "shut off". Disconnect the red battery lead from terminal M6 of the lower PCA. Remove the intermediate cable from the J3 connector of the lower PCA. Using an ohmmeter, test between terminal 4 (green wire) and terminal 6 (brown wire) of the intermediate cable. The ohmmeter should read approximately 1000W.
16. Test between terminal 4 (green wire) and terminal 5 (black wire) of the intermediate cable and between terminal 5 (black wire) and terminal 6 (brown wire) of the intermediate cable. These two readings should total approximately 1000W.
17. If the readings in steps 15 and 16 are correct, skip to step 19. If either reading is significantly high or low, continue with step 18.

18. Disconnect the intermediate cable from the incline motor cable. Using an ohmmeter read each of the six wires in the intermediate cable from end to end. Each of the wires in the intermediate cable should read less than 1W. If any of the readings are significantly high, replace the intermediate cable. If all of the readings are correct, continue with step 19.
19. Replace the incline motor. Calibrate the incline motor per Procedure 8.3.

Section Ten - EFX Replacement Procedures

Procedure 10.1 – Replacing the Rear Covers

WARNING

Before continuing with this procedure, review the Warning and Caution statements listed in Section One, Things You Should Know.

Replacing the Left and/or Right Side Rear Cover

1. Remove the two screws at the rear of the rear cover.
2. Grasp the left side cover and rotate it clockwise to remove it.
3. Grasp the right side cover rotate it counterclockwise to remove it.
4. Reverse steps 2 and three to replace the left and ride side covers. Replace the screws removed in step 1 to fasten the left and right side covers.

Replacing the Top Section of the Rear Cover

5. Remove the left and right side covers as described above.
6. Loosen, do not remove, the two screws that fasten the top cover to the frame upright.
7. Remove the two screws that fasten the top cover to the front cover and remove the top cover.
8. Set the replacement top cover in its mounting position and fasten it with the four screws removed in steps 2 and 3.
9. Replace the left and right side covers as described above.

Replacing the Rear Section of the Rear Cover

10. Remove the left and right side covers as described above.

Diagram 10.1.1 - External Power Supply Input Jack

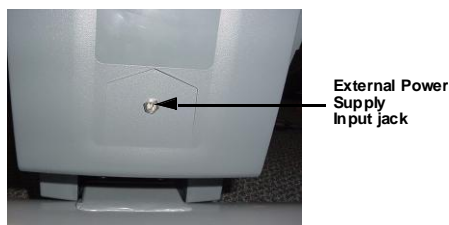

11. Remove the top section of the cover as described above.

12. Remove the nut retaining the external power supply input jack. Refer to Diagram 10.1.1
13. Remove the external power supply input jack from the cover.
14. Remove the four screws (2 each side) that fasten the cover to the frame. Slide the two wire clips off of the cover's left side. Remove the cover from the EFX.
15. Set the replacement cover in its mounting position and fasten it with the screws removed in step 12. Slide the two wire clips into place on the covers left side.
16. Set the external power supply input jack at its mounting location and fasten it with the nut removed in step 10.
17. Replace the left and right side covers as described above.

Replacing the Front Section of the Rear Cover

18. Remove the left and right side covers as described above.
19. Remove the top section of the cover as described above.
20. Remove the four screws that fasten the rear cover section to the frame. Carefully slide the rear cover section rearwards a couple of inches to clear the overlap between the front and rear cover sections.
21. Remove the cables from the two lower cable clips on the inside of the front section of the cover.
22. Remove the two screws that fasten the lower PCA mounting bracket to the front section of the cover. Refer to Diagram 10.1.2.

Diagram 10.1.2 - Lower PCA Mounting Bracket

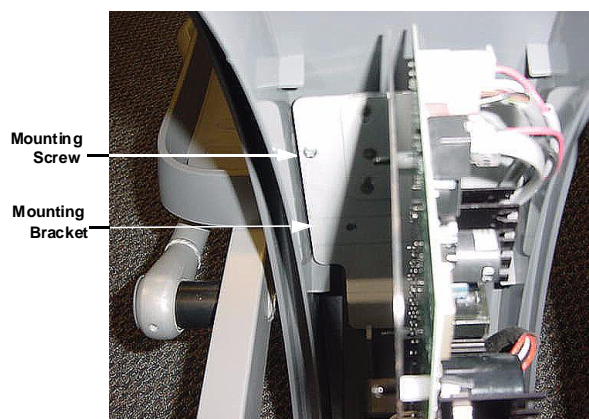

23. Remove the lower PCA and bracket and carefully support it away from the front section of the cover.
24. Remove the small cover at the front portion of the cover section by sliding it forward and off of the front section of the cover. Refer to Diagram 10.1.3. Remove the two cover mounting screws.

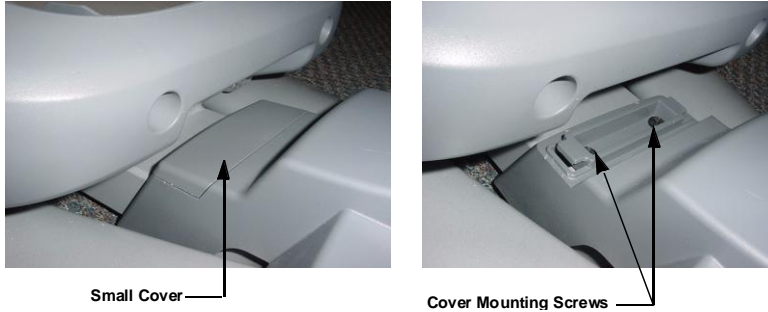
Diagram 10.1.3 - Small Cover

25. Remove the front section of the cover from the EFX. Remove the cable clips from the cover and snap them into their mounting positions in the replacement cover.
26. Set the replacement cover in its mounting position. Fasten the cover with the two screws removed in step 25. Slide the small cover, removed in step 24, onto the front section of the cover.
27. Slide the rear section of the cover back into its mounting position and fasten it with the four screws removed in step 20.
28. Set the lower PCA and mounting bracket in its mounting position and fasten it with the two screws removed in step 22.
29. Press the cables, remove in step 21, into the two lower cable clips on the front section of the cover.
30. Replace the top section of the cover as described above.
31. Replace the left and right cover sides as described above.

Procedure 10.2 – Replacing the Lift Covers

1. The large upper section of the front cover is fastened to the lower cover sections. However, there are two plastic clips, one on each side of the upper lift cover, that retain the upper portion of the lift cover to the uprights. To remove the upper lift cover section, lower the incline to its lowest position, to provide clearance.
2. The plastic cover clips must be carefully levered out of their mountings. Insert a narrow flat bladed screw driver in the slot in the front of the cover clip. See Diagram 10.2.1.

Diagram 10.2.1 - Lift Cover Clip

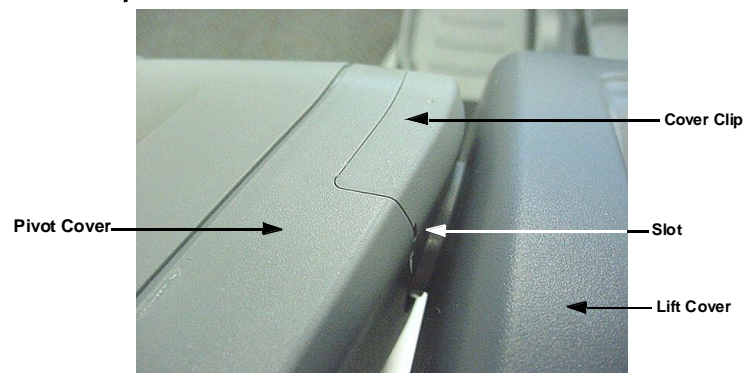

3. Carefully pry the cover clip away from the pivot cover. There are latching tabs in the front and rear of the cover clip. All of the latching tabs must disengage from the pivot cover in order to remove the cover clip.
4. Lift the upper lift cover section off of the lower cover sections.
5. Set the replacement upper lift cover section on in its mounting position on the lower cover sections.
6. Replace the cover clips by setting them in their mounting position and pressing them into place. Press the rear portion of the clip into place first then the front portion of the cover clip.

Replacing the Lower Front Lift Cover Section

7. Remove the upper lift cover section as described above.
8. Remove the four screws that fasten the front cover section to the rear cover section. Remove the front cover section from the EFX.
9. Set the replacement front cover section in its mounting position and fasten it with the four screws removed in step 4.

Replacing the Lower Rear Lift Cover Section

10. Remove the upper and front cover sections as described above.
11. Remove the hitch pin from the clevis at the lower mount of the incline motor. Remove the clevis pin from the lower incline motor mount. Lift the incline motor out of its mounting position and set it on the floor in front of the EFX. Refer to Diagram 10.2.2.
12. Remove the two screws that fasten the battery bracket to the rear cover section and remove the battery bracket.
13. Slide the battery out of the rear cover section and set it on the floor beside the incline motor.
14. Remove the two screws that fasten the rear cover section to the frame. Remove the rear cover section from the EFX.
15. Set the replacement rear cover section in its mounting position and fasten it with the screws removed in step 10.
16. Set the battery in its mounting position. Set the battery bracket in its mounting position and fasten it with the screws removed in step 8.

Diagram 10.2.2 - Rear Cover Section

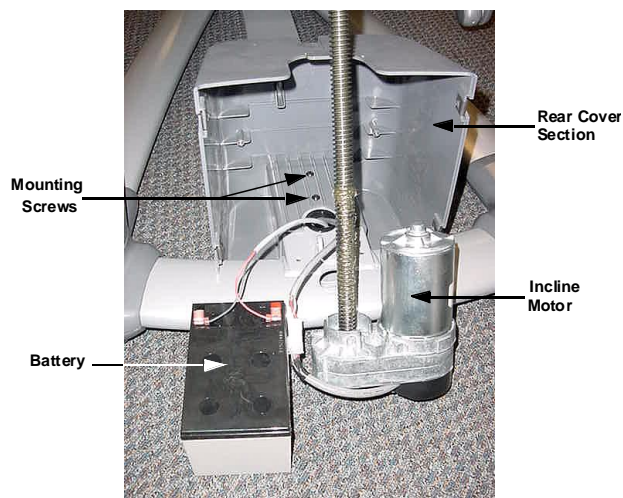

17. Set the incline motor in its mounting position and slide the clevis pin into the incline motor's lower mount. Fasten the clevis pin with the hitch pin.
18. Replace the front and upper cover sections as described above.

Procedure 10.3 - Replacing the Lower PCA

Removing the Lower PCA

1. Remove the rear cover and disconnect the red battery lead from terminal M6 of the lower PCA.

WARNING

Before continuing with this procedure, review the Warning and Caution statements listed in Section One, Things You Should Know.

2. Remove the right side rear cover per Procedure 10.1.
3. Attach the wrist strap to your arm, and then connect the ground lead of the wrist strap to the EFX frame.
4. Disconnect the all of cables and wiring from the lower PCA.
5. Remove the four screws that secure the lower PCA to its mounting bracket, refer to Diagram 10.3.1.

Diagram 10.3.1 - Lower PCA

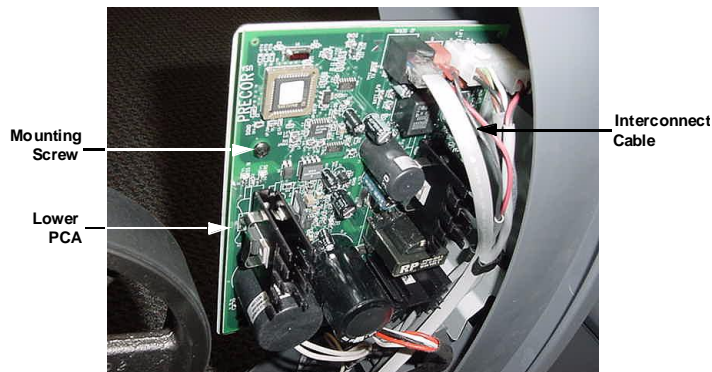

Replacing the Lower PCA

6. Position the replacement lower PCA at its mounting position and fasten the lower PCA with the four screws removed in step 5.
7. Reconnect the lower PCA cables and wiring as follows. Connect the interconnect cable to connector J2. The 2 conductor cable (red and black wires) from the input power jack to the J4 connector. The 6 conductor cable from the generator to connector J1. The 6 conductor cable from the incline motor to connector J5. From the battery, connect the red wire to M6 and the black wire to M7 of the lower PCA. Connect the two leads from the load resistors to M1 and M2, the polarity of the load leads is not critical, either lead may be connected to either the M1 or M2 terminal.

8. Remove the ground lead of the wrist strap from the EFX frame, and then remove the wrist strap from your arm.
9. Re-install the rear cover, and then check the operation of the EFX 885, 835 as described in Section Seven.

Procedure 10.4 – Replacing the Upper or Lower Interconnected Cables

Before you install a new interconnect cable, ensure that the interconnect cable is defective as described in Procedure 10.4.

WARNING

Before continuing with this procedure, review the Warning and Caution statements listed in Section One, Things You Should Know.

1. Attach the wrist strap to your arm, and then connect the ground lead of the wrist strap to the EFX frame.

Replacing the Upper Interconnect Cable

2. Remove the display housing per Procedure 3.5 (P80) or 5.5 (P30).
3. The upper and lower interconnect cables are connected behind the access cover below the display. Refer to Diagram 9.1.1.
4. Disconnect the upper interconnect cable from the mid-point connector. Tape the end of the replacement interconnect cable to the upper end of the old interconnect cable (display housing end).
5. Carefully pull the old interconnect cable out of the mid-point access hole while feeding the new interconnect cable into the unit. When the new cable is fully into the unit, remove the tape and discard the old interconnect cable. Connect the upper interconnect cable to the mid-point connector and push them into the access hole.
6. Connect the upper interconnect cable to the upper PCA. Replace the display housing per Procedure 3.5 (P80) or 5.5 (P30).
7. Remove the ground lead of the wrist strap from the EFX frame, and then remove the wrist strap from your arm.
8. Check the operation of the EFX as described in Section Seven.

Replacing the Lower Interconnect Cable

9. Remove the right side rear cover per Procedure 10.1. Disconnect the interconnect cable from the lower PCA (connector J2). Refer to Diagram 10.3.1.
10. The upper and lower interconnect cables are connected behind the access cover below the display. Refer to Diagram 9.1.1.
11. Disconnect the lower interconnect cable from the mid-point connector. Tape the replacement interconnect cable to the old interconnect cable at the lower PCA end of the old interconnect cable.

12. Carefully pull the old interconnect cable out of the mid-point access hole while feeding the new interconnect cable into the unit. When the new cable is fully into the unit, remove the tape and discard the old interconnect cable. Connect the lower interconnect cable to the mid-point connector and push them into the access hole.
13. Connect the new interconnect cable to the lower PCA.
14. Check the operation of the EFX as described in Section Four.

Procedure 10.5 – Replacing a Crankarm Assembly

WARNING

Before continuing with this procedure, review the Warning and Caution statements listed in Section One, Things You Should Know.

1. It is only necessary to remove the right or left side of the rear cover to access the crankarm being replaced. Remove the necessary side(s) of the rear cover.
2. Remove the stairarm assembly as described in Procedure 10.13.

Note:

Notice the position of the two crank arms. When the crankarms are replaced, they must be positioned so that they are 180 degrees opposing.

3. Remove the axle bolt that secures the crankarm to the input pulley shaft. Remove the pinch bolt. Refer to Diagram 10.5.1. It may be necessary, use a Pitman arm puller or 4" to 6" gear puller to remove the crankarm. Do not use a hammer or mallet to remove the crankarm.
4. If you are removing both crank arm assemblies, repeat steps 2 and 3 for the second crankarm assembly.

Diagram 10.5.1 – Crankarm

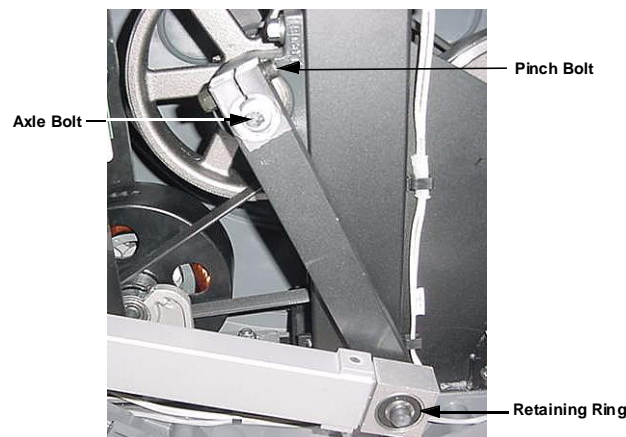

Replacing a Crank Arm Assembly

5. Clean the crankarm mounting bolt threads and the input pulley shaft threads with an alcohol swab. Allow them to dry and apply blue loctite to the crankarm mounting bolt threads.
6. Position the crankarm on the input pulley shaft. Thread and hand tighten the axle bolt into the input pulley shaft. Torque the axle bolt to 200 in/lbs.

7. Replace the pinch bolt and locknut, torque the pinch bolt to 400 inch pounds.
8. Replace the stairarm assembly as described in Procedure 10.13, steps 11 to 12.
9. If you are replacing both crankarm assemblies, repeat steps 6 and 7 for the second crankarm assembly.
10. Replace the right side and/or left side rear cover.

Procedure 10.6 – Replacing a Incline Motor

1. Remove upper and front cover sections per Procedure 10.2.
2. Remove the hitch pin from the clevis at the lower incline motor mount. Remove the clevis pin from the lower incline motor mount.
3. Carefully lift the incline motor out of its mount and set it on the floor in front of the EFX, Refer to Diagram 10.6.1.

Diagram 10.6.1 - Incline Motor

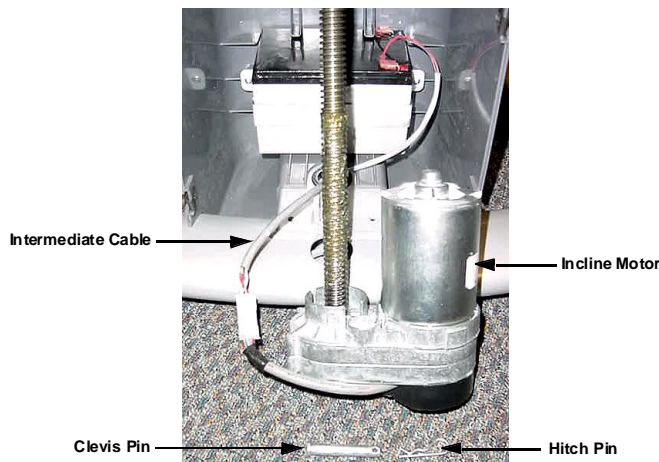

4. Disconnect the intermediate cable from the incline motor cable.
5. Remove the two bolts that fasten the incline motor yoke into the ramp. Refer to Diagram 10.14.2.
6. Carefully, slide the incline motor yoke out of the ramp and lower the ramp until it is resting on the frame.
7. Thread the incline yoke assembly off of the incline motor's drive screw.
8. Thread the incline yoke assembly, removed in step 7, onto the replacement incline motor's drive screw.
9. Connect the replacement incline motor's cable to the intermediate cable.
10. Mount the incline motor to the EFX frame with the clevis and hitch pins removed in step 2.
11. Calibrate the incline motor per Procedure 8.3.
12. Replace front and upper cover sections per Procedure 10.2.
13. Check the operation of the EFX as described in Section Seven.

Procedure 10.7 – Replacing the Input Pulley Belt

WARNING

Before continuing with this procedure, review the Warning and Caution statements listed in Section One, Things You Should Know.

1. Remove the left and right side rear covers per Procedure 10.1.
2. Remove the stairarm assemblies as described in Procedure 10.13
3. Remove the crankarm assemblies as described in Procedure 10.5.
4. Remove the input pulley assembly per Procedure 10.9.
5. Remove the left and right tension bolts, locking tabs and brackets from the step up pulley assembly. Remove the generator belt from the generator's pulley.
6. Slide the step up pulley assembly with both the generator and input pulley belts out of the drive unit.
7. Remove the input pulley belt. Set the replacement input pulley belt in its mounting position on the step up pulley assembly.
8. Set the step up pulley assembly with the generator and input belt at its mounting position in the drive unit. Replace the tensioning bolts, locking tabs and brackets removed in step 6. Thread, but do not tighten, the left and right tension bolts into the step up pulley shaft.
9. Place the other end of the generator belt on the generator's pulley.
10. Place the other end of the input pulley belt on the input pulley assembly and mount the input assembly per Procedure 10.9
11. Replace the crankarm assemblies per Procedure 10.5.
12. Replace the stairarm assemblies per Procedure 10.13
13. Tension both belts per Procedure 8.2. Note the differences between tensioning a new belt and a existing (used) belt.
14. Check the operation of the EFX as described in Section Four.

Procedure 10.8 – Replacing the Generator Pulley Belt

WARNING

Before continuing with this procedure, review the Warning and Caution statements listed in Section One, Things You Should Know.

1. Remove the left and right side rear covers per Procedure 10.1.
2. Remove the stairarm assemblies as described in Procedure 10.13
3. Remove the crankarm assemblies as described in Procedure 10.5.
4. Remove the input pulley assembly per Procedure 10.9
5. Remove the left and right tension bolts, locking tabs and brackets from the step up pulley assembly.
6. Remove the three generator mounting screws shown in Diagram 8.2.1.
7. Remove the two bearing clamp screws shown in Diagram 10.17.2. Remove the bearing clamp.
8. Lift the generator and remove its drive belt.
9. Slide the step up pulley assembly with both the generator and input belts out of the drive unit.
10. Remove the generator belt. Set the replacement generator belt in it's mounting position on the step up pulley assembly.
11. Set the step up pulley assembly with the generator and input belt at its mounting position in the drive unit. Replace the tensioning bolts, locking tabs and brackets removed in step 6. Thread, but do not tighten, the left and right tension bolts into the step up pulley shaft.
12. Lift the generator and place the drive belt around the generator's pulley.
13. Replace and tighten the three generator mounting screws removed in step 6. Set the bearing clamp in its mounting position, replace and tighten the two bearing clamp mounting screws removed in step 7.
14. Mount the input assembly per Procedure 10.9.
15. Replace the crankarm assemblies per Procedure 10.5.
16. Replace the stairarm assemblies per Procedure 10.13.
17. Tension both belts per Procedure 8.2. Note the differences between tensioning a new belt and an existing (used) belt.
18. Check the operation of the EFX as described in Section Seven.

Procedure 10.9 – Replacing the Input Pulley Assembly

WARNING

Before continuing with this procedure, review the Warning and Caution statements listed in Section One, Things You Should Know.

1. Remove the left and right side rear covers per Procedure 10.1.
2. Remove the stairarm assemblies as described in Procedure 10.13.
3. Remove the crankarm assemblies as described in Procedure 10.5
4. Remove the input pulley assembly mounting nuts (2 per pillow block bearing).
5. Straighten the locking tabs and turn the left and right tension bolts counterclockwise until tension is removed from the both belts. (Refer to Diagram 8.2.1)

Diagram 10.9.1 - Input Pulley Assembly

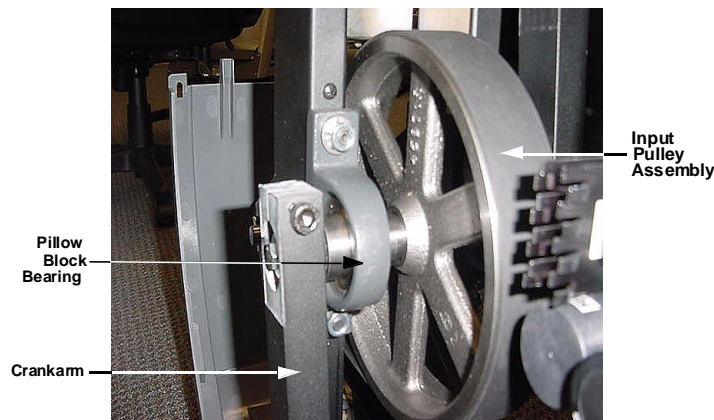

6. Remove the input pulley assembly. Slide input pulley belt off of the input pulley assembly.
7. Hold the replacement input pulley assembly at its mounting position and slide the input belt over and past the pillow block bearing and onto the input pulley assembly.
8. Replace the nuts on the pillow block bearings and torque them to 400 inch pounds.
9. Replace the crankarms per Procedure 7.7. The crankarms must be parallel to the frame uprights. Refer to Diagram 10.9.1. If necessary loosen the four drive unit mounting bolts, align the drive unit and torque the drive unit mounting bolts to 400 inch pounds.
10. Tension both belts per Procedure 8.2. Note the differences between tensioning a new belt and a existing (used) belt.
11. Replace the left and right side rear covers.

Procedure 10.10 – Replacing the Input Step Up Pulley Assembly

WARNING

Before continuing with this procedure, review the Warning and Caution statements listed in Section One, Things You Should Know.

1. Remove the left and right side rear covers per Procedure 10.1.
2. Remove the stairarm assemblies as described in Procedure 10.13.
3. Remove the crankarm assemblies as described in Procedure 10.5
4. Remove tension from the input pulley and generator belts as described below:
 - a. Straighten the locking tabs and turn the left and right tension bolts counterclockwise until tension is removed from the both belts. (Refer to Diagram 8.2.1)
 - b. Remove both tension bolts and slide the input belt off of the step up pulley assembly.
5. Place the input belt and step up belt in place on the replacement step up pulley. Set other
6. Place the input belt and step up belt in place on the replacement step up pulley. Set other end of the generator belt on the generator pulley.
7. Replace the tension bolts and associated hardware removed in step 4b.
8. Tension both belts per Procedure 8.2. Note the differences between tensioning a new belt and a existing (used) belt.
9. Replace the crankarms per Procedure 10.5.
10. Replace the left and right side rear covers.

Procedure 10.11 – Replacing the Stairarm Wheel

Procedure

WARNING

Before continuing with this procedure, review the Warning and Caution statements listed in Section One, Things You Should Know.

1. Remove the lift cover per Procedure 10.2.
2. Grasp the center ramp cover and lift it upwards to unsnap it from the ramp. Remove the center ramp cover from the EFX and set it aside.
3. Remove the two screws that fasten the ramp end cap to the ramp. Remove the ramp end cap. Refer to Diagram 10.11.1.

Diagram 10.11.1 -Ramp Assembly

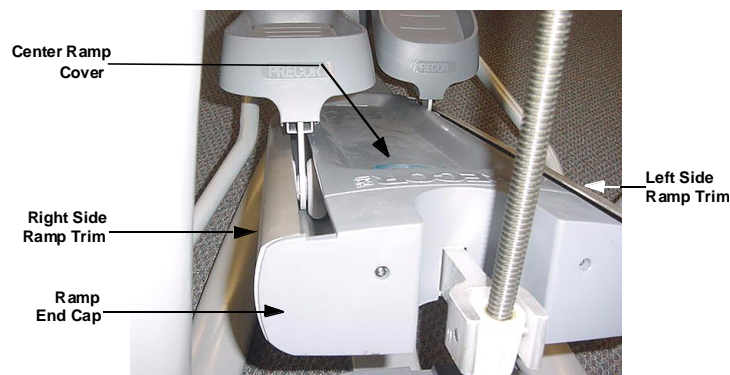

4. The left side and/or right side ramp trim will need to be removed in order to access the stairarm wheels.
5. Loosen, but do not remove, the five screws that fasten ramp trim(s) required to access the wheel(s) being replaced. Slide the ramp trim(s) off the front of the ramp.
6. Remove the screw retaining the wheel being replaced. Refer to Diagram 10.11.1. Slide the wheel off the stairarm axle.

Diagram 10.11.2 - Stairarm Wheel



7. Slide the replacement wheel onto the stairarm axle. Fasten the wheel with the hardware removed in step 6. Apply blue loctite to the wheel mounting screws and torque them to 180 inch pounds.
8. Repeat the procedure in steps 6 and 7 for each wheel being replaced.
9. Align the T-nuts on the ramp trim(s) with the channel in the bottom front of the ramp. Slide the trim onto the ramp while feeding each T-nut into the ramp channel. Do not tighten the trim fastening screws at this time. Repeat this procedure with the remaining trim strip, if required.
10. Set the ramp end cap at its mounting position and fasten it with the screws removed in step 3.
11. Align the ramp trim(s) with the ramp end cap and tighten the five trim mounting screws.
12. Set the ramp center cover at its mounting position and press downward to snap it onto place.
13. Replace the lift cover per Procedure 10.2.

Procedure 10.12 – Replacing the Stairarm Pedal

1. Loosen and remove the four screws that fasten the stairarm pedal onto the stairarm. Refer to Diagram 10.12.1.
2. Remove the stairarm pedal from the stairarm.
3. Set the replacement stairarm pedal at its mounting position on the stairarm.
4. Install and tighten the stairarm pedal mounting hardware removed in step 2.

Diagram 10.12.1 - Stairarm Pedal



Procedure 10.13 – Replacing the Stairarm

1. Remove the left and right side rear cover.
2. Remove the cover from the rear of the stairarm. The cover's retaining screw is on the inside and must be accessed from the opposite side of the EFX. Carefully, rotate the stairarm to a position just forward of vertical to gain access to the cover's retaining screw.
3. Remove the lift cover per Procedure 10.2.
4. Grasp the center ramp cover and lift it upwards to unsnap it from the ramp. Remove the center ramp cover from the EFX and set it aside.
5. Remove the two screws that fasten the ramp end cap to the ramp. Remove the ramp end cap. Refer to Diagram 10.11.1.
6. The left side and/or right side ramp trim will need to be removed in order to access the stairarm wheels.
7. Loosen, but do not remove, the five screws that fasten ramp trim(s) required to access the wheel(s) being replaced. Slide the ramp trim(s) off the front of the ramp.

Diagram 7.14 - Stairarm and Stairarm Connector

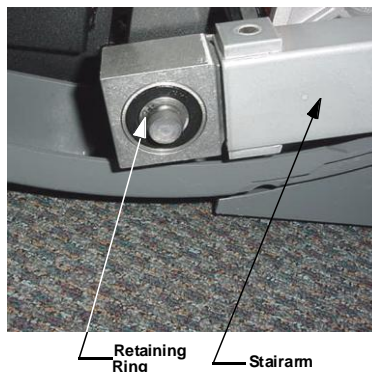

8. Remove the retaining ring that fastens the stairarm to the crankarm and remove the stairarm from the EFX.
9. Remove the stairarm pedal per Procedure 10.12 and install it on the replacement stairarm.
10. Remove both wheels and slide them onto the replacement stairarm's axle. Apply blue loctite to the wheel mounting screws and torque the wheel mounting screws to 180 inch pounds.
11. Slide the stairarm onto the crankarm and set the stairarm in its ramp track. Fasten the stairarm to the crankarm with the retaining ring removed in step 7.

12. Align the T-nuts on the ramp trim(s) with the channel in the bottom front of the ramp. Slide the trim onto the ramp while feeding each T-nut into the ramp channel. Do not tighten the trim fastening screws at this time. Repeat this procedure with the remaining trim strip, if required.
13. Set the ramp end cap at its mounting position and fasten it with the screws removed in step 3.
14. Align the ramp trim(s) with the ramp end cap and tighten the five trim mounting screws.
15. Set the ramp center cover at its mounting position and press downward to snap it onto place.
16. Replace the lift cover per Procedure 10.2.
17. Replace the stairarm cover(s) with the hardware removed in step 2.
18. Replace the left and right side covers per Procedure 10.2.

Procedure 10.14 - Replacing the Ramp Assembly

Procedure

1. Raise the incline to its highest position.
2. Remove both stairarms per Procedure 10.13.
3. Remove the four bolts that fasten the ramp pivot to the ramp. Refer to Diagram 10.14.1.

Diagram 10.14.1 - Rear Ramp Mounting



4. Remove the two bolts that fasten the incline yoke into the ramp. Refer to Diagram 10.14.2. Carefully, slide the incline out of the ramp and lower the ramp to the frame. Take care to not allow the incline yoke to rotate on the incline motor's drive screw. If the yoke can not be returned to the same position it was in before the incline yoke was removed, an incline calibration (Procedure 8.3) must be performed before the incline motor is reinstalled in the ramp.

Diagram 10.14.2 - Front Ramp Mounting

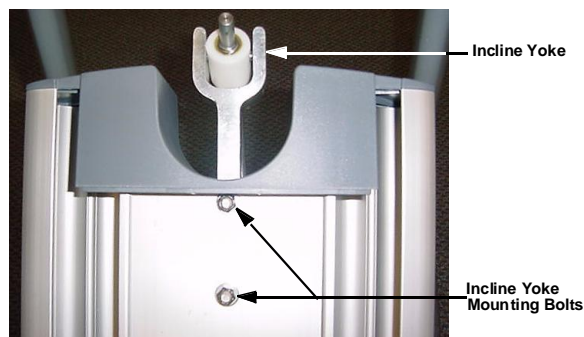

5. Remove the ramp from the EFX.
6. Remove the two screws that fasten the rear ramp end cap to the ramp. Set the rear ramp end cap at its mounting position on the replacement ramp and fasten with the screws removed above.
7. Set the replacement ramp in its mounting position and hand start ramp pivot mounting bolts removed in step 3. Do not tighten them at this time.
8. Slide incline yoke into its mounting position in the ramp and fasten it with the hardware removed in step 4.
9. Apply blue loctite to the four ramp pivot bolts (hand started in step 7) and torque them to 480 inch pounds (40 foot pounds).
10. Slide the stairarm onto the crankarm and set the stairarm in its ramp track. Fasten the stairarm to the crankarm with the retaining ring removed in step 7.
11. Replace the stairarm connector per Procedure 10.16.
12. Align the T-nuts on the ramp trim(s) with the channel in the bottom front of the ramp. Slide the trim onto the ramp while feeding each T-nut into the ramp channel. Do not tighten the trim fastening screws at this time. Repeat this procedure with the remaining trim strip, if required.
13. Set the ramp end cap at its mounting position and fasten it with the screws removed in step 3.
14. Align the ramp trim(s) with the ramp end cap and tighten the five trim mounting screws.
15. Set the ramp center cover at its mounting position and press downward to snap it onto place.
16. Replace the lift cove per Procedure 10.2.

Procedure 10.15 – Future Content

Procedure 10.16 – Future Content

Procedure 10.17 – Replacing a Generator

WARNING

When the unit is used, stairarms are in motion or the generator is rotated by any means, the generator will produce potentially hazardous voltages even when the battery is disconnected.

1. Remove the rear cover and disconnect the red battery lead from terminal M6 of the lower PCA.
2. Remove the three generator mounting screws shown in Diagram 10.17.1.
3. Remove the two bearing clamp screws shown in Diagram 10.17.2. Remove the bearing clamp.
4. Lift the generator and remove its drive belt.
5. Loosen all four generator mounting nuts. Loosen the locking nut on the generator's adjustment bolt and thread the adjustment bolt into tab to remove tension from the generator's drive belt. Remove the drive belt from the generator's pulley.
6. Remove the four generator mounting nuts. Disconnect the generator's cable connector from the intermediate cable and remove the generator from the EFX.
7. Remove the adjustment bolt and its locking nut from the generator's mounting base.
8. Thread the adjustment bolt and locking nut into the tab on the replacement generator.

Diagram 10.17.1 - Generator Mounting



9. Set the replacement generator at its mounting position. Remove the three generator mounting screws, the two bearing clamp screws and the bearing clamp. Lift the generator and place the drive belt around the generator's pulley.

Diagram 10.17.2 - Generator Bearing Clamp

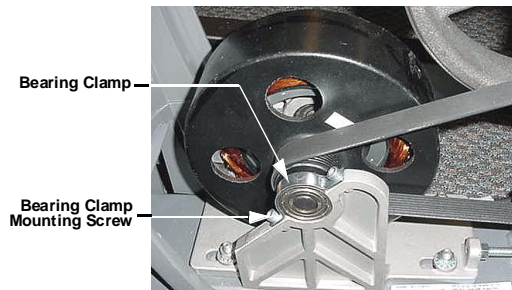

10. Replace and tighten the three generator mounting screws removed in step 9. Set the bearing clamp in its mounting position, replace and tighten the two bearing clamp mounting screws removed in step 9.
11. Hand start, but do not tighten the four mounting nuts removed in step 6. The generator must be able to move in order to adjust the belt tension.
12. Adjust the generator drive belt tension per Procedure 8.2.
13. Reconnect the red battery lead removed in step 1 and replace the rear cover.
14. Check the operation of the EFX as described in Section Seven.

Procedure 10.18 – Replacing a Battery

1. Remove the lift cover per Procedure 10.2.
2. Remove the four screws that retain the lower front cover section, remove the lower front cover section and set it aside.
3. Remove the hitch pin from the clevis at the lower mount of the incline motor. Remove the clevis pin from the lower incline motor mount. Lift the incline motor out of its mounting position and set it on the floor in front of the EFX. Refer to Diagram 10.18.2.

Diagram 10.18.2 - Replacing a Battery

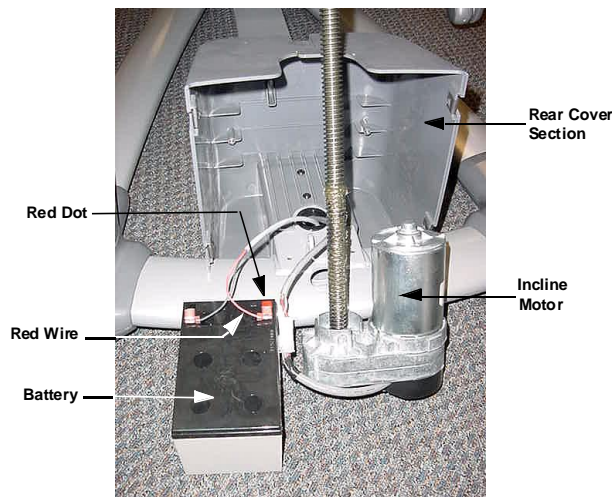

4. Remove the two screws that fasten the battery bracket to the rear cover section and remove the battery bracket.
5. Slide the battery out of the rear cover section and set it on the floor beside the incline motor.
6. Disconnect the red and black wires from the battery.
7. Connect the red and black wires disconnected in step 6 to the replacement battery. The red wire must be connected to the terminal marked with the red dot.
8. Set the battery in its mounting position. Set the battery bracket in its mounting position and fasten it with the screws removed in step 8.
9. Set the incline motor in its mounting position and slide the clevis pin into the incline motor's lower mount.
10. Fasten the clevis pin with the hitch pin.
11. Set the lower front cover section in its mounting position and fasten it with the four screws removed in step 2.
12. Replace the lift cover per Procedure 10.2.

Procedure 10.19 – Replacing an External Power Input Jack

1. Remove the left and right side rear covers sections per Procedure 10.1.
2. Disconnect the J4 connector from the lower PCA.

Diagram 10.19.1 - Power Input Jack Mounting

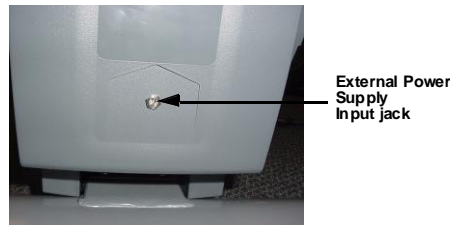

3. Remove the nut that fastens the external power input jack to the rear cover support. Refer to Diagram 10.19.1.
4. Remove the power jack's wiring from the wire clips and discard the power jack and wiring.
5. Fasten the replacement external power input jack into the cover with the mounting nut provided with the power input jack.
6. Route the power input jack wiring through the wire clips to the lower PCA. Connect the plug on the power input jack wiring to the J4 connector on the lower PCA.
7. Replace the left and right side rear covers.
8. Check the operation of the EFX as described in Section Seven.

Procedure 10.20 – Replacing a Ramp Pivot

Procedure

1. Raise the incline to its highest position.
2. Remove the four bolts that fasten the ramp pivot to the ramp. Refer to Diagram 10.21.1.

Diagram 10.21.1 - Rear Ramp Mounting



3. Remove the two pivot bolts, washers and steel spacers from the ramp pivot.
4. Remove the ramp pivot from the ramp.
5. Set the replacement ramp pivot in its mounting and hand start, but do not tighten, the four mounting bolts and washers removed in step 2.
6. Slide the two steel spacers into the ramp pivot, hand start the two pivot bolts and washers removed in step 3.
7. Torque the four mounting bolts to 480 inch pounds (40 foot pounds).
8. Torque the two pivot bolts to 780 inch pounds (65 foot pounds).
9. Thoroughly, test all incline functions.

Section Eleven - Future Content

Section Twelve - Future Content

Section Thirteen - Future Content

Section Fourteen - Wiring Diagrams

Wiring Diagram 14.1 - EFX

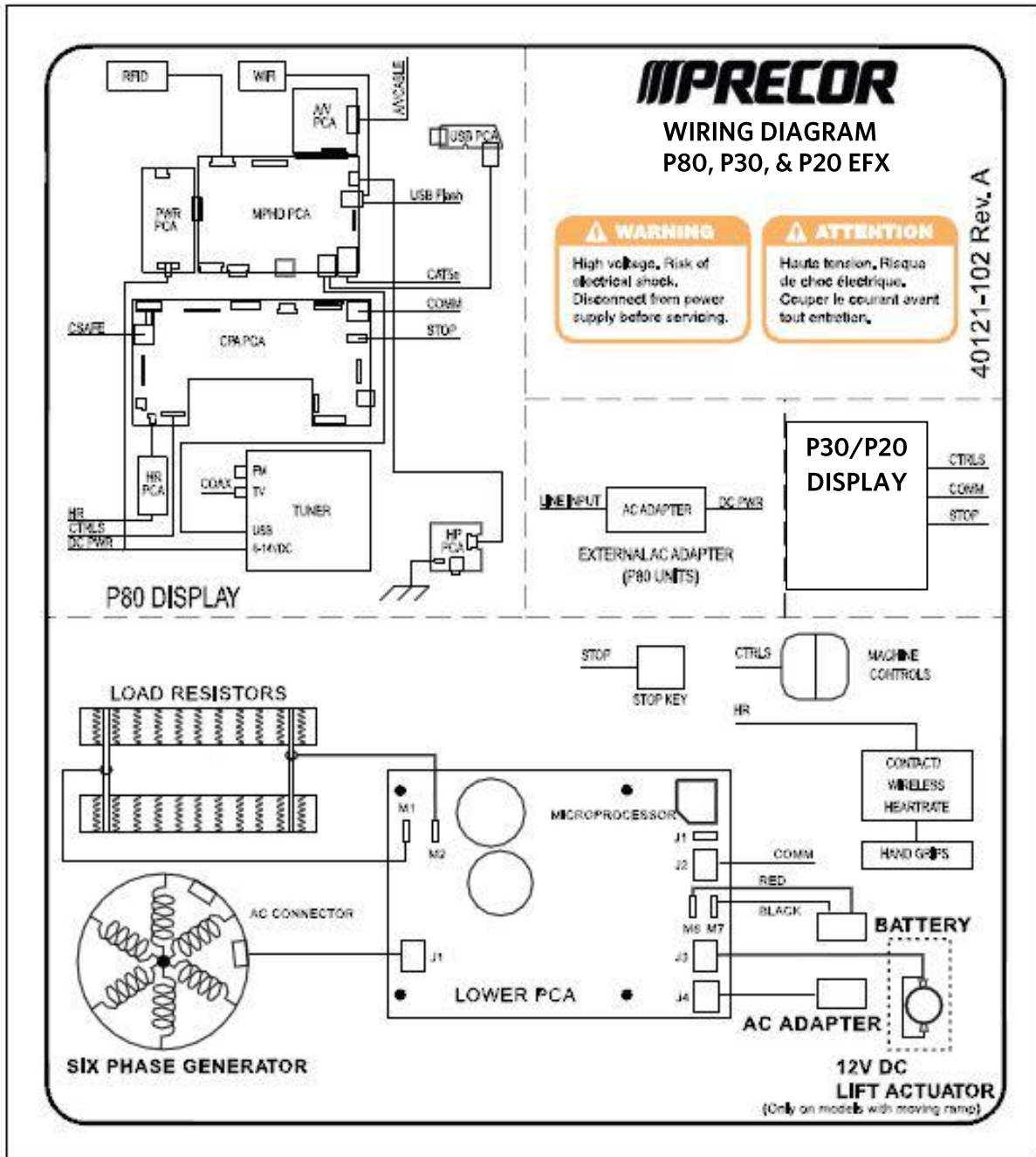

Block Diagram 14.2 – EFX 833

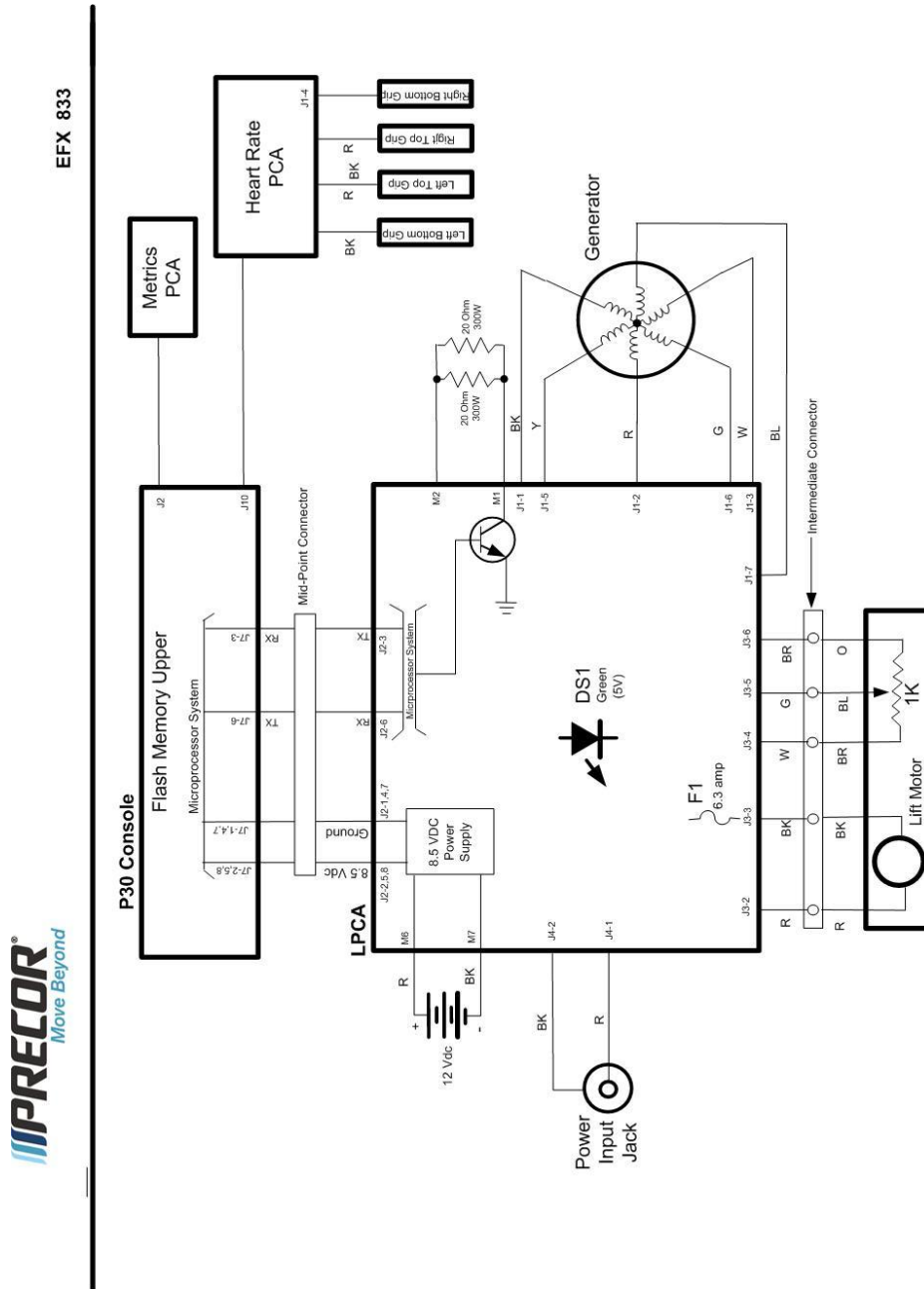

EFX 833

PRECOR
Move Beyond